



Back



Previous



Next

TOP

ENG

Before Using the Machine 1

Document and Paper 2

Sending and Receiving 3

Copying 4

Printing (FAX-L160 Only) 5

System Manager Settings 6

Maintenance 7

Troubleshooting 8

Appendix 9

Table of Contents

Index



Reference Guide

FAX-L160/L140



**Please read this guide before operating this product.
After you finish reading this guide, store it in a safe place
for future reference.**

How to Use This Guide



Back



Previous



Next

TOP

Before Using the Machine 1

Document and Paper 2

Sending and Receiving 3

Copying 4

Printing (FAX-L160 Only) 5

System Manager Settings 6

Maintenance 7

Troubleshooting 8

Appendix 9

Table of Contents

Index

Manuals for the Machine



Starter Guide



Reference Guide
(This Document)
(Located on User software CD)

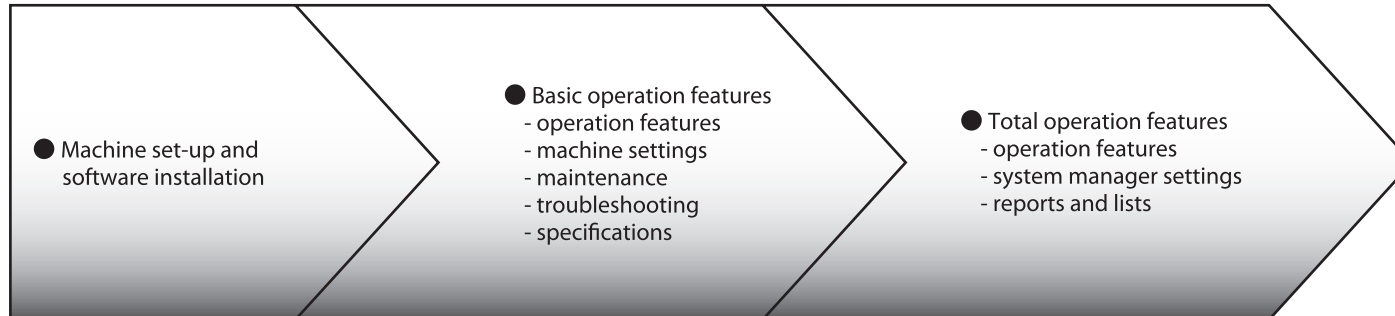

- To view the manual in PDF format, Adobe Reader/Adobe Acrobat Reader is required. If Adobe Reader/Adobe Acrobat Reader is not installed on your system, please download it from the Adobe Systems Incorporated website.
- Considerable effort has been made to make sure that the manuals for the machine are free of inaccuracies and omissions. However, as we are constantly improving our products, if you need an exact specification, please contact Canon.
- The machine illustration on the cover may differ slightly from your machine.



Back



Previous



Next

TOP

Before Using the Machine 1

Document and Paper 2

Sending and Receiving 3

Copying 4

Printing (FAX-L160 Only) 5

System Manager Settings 6

Maintenance 7

Troubleshooting 8

Appendix 9

Things You Can Do

Specify a recipient with a single key

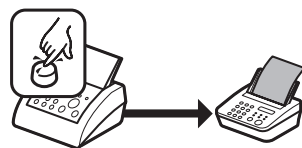

One-Touch Speed Dialing Keys
→ p. 3-14

Look up a particular recipient



Address Book Search
→ p. 3-15

Receive faxes in memory without printing out

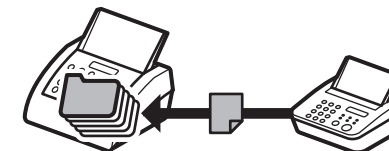

Memory Lock Reception
→ p. 3-25

Specify a recipient with a two-digit code

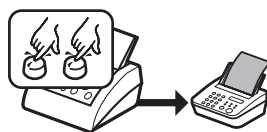

Coded Speed Dialing Codes
→ p. 3-14

Redial when the line is busy



Redialing
→ p. 3-19

Reject faxes without their numbers

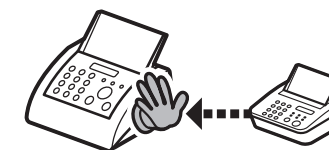

RX Restriction
→ p. 3-29

Specify multiple recipients as a group

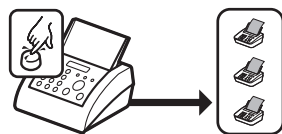

Group Dialing
→ p. 3-15

Send documents to multiple recipients

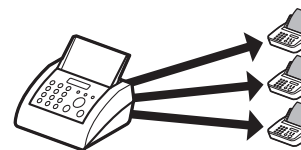

Broadcasting
→ p. 3-30

Send a fax at a specified time

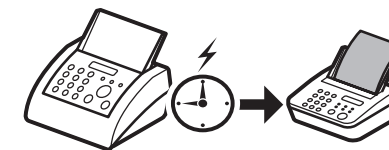

Delayed Sending
→ p. 3-30

Table of Contents

Index



Back



Previous



Next

TOP

Before Using the Machine 1

Document and Paper 2

Sending and Receiving 3

Copying 4

Printing (FAX-L160 Only) 5

System Manager Settings 6

Maintenance 7

Troubleshooting 8

Appendix 9

Table of Contents

Index

Send or receive a fax automatically upon request

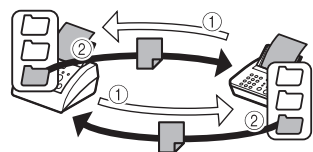

Polling
→ p.3-31

Adjust the density level of scanned images



Density
→ p.4-3

Sort printouts by page order*1

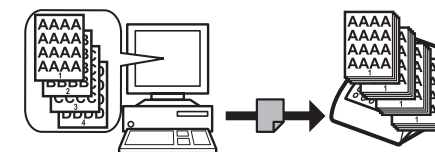

Collate Printing
→ p.5-3

Send a fax to be relayed to other fax machines

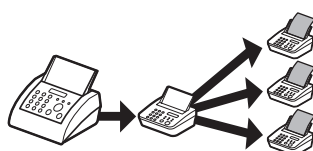

Relay
→ p.3-33

Enlarge or reduce copied images

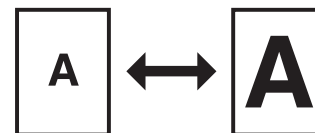

Zoom Ratio
→ p.4-4

Restrict the use of the machine with a password

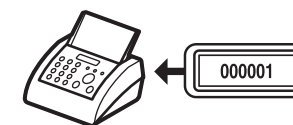

System Manager Settings
→ p.6-2

Select a scan mode depending on the type of image

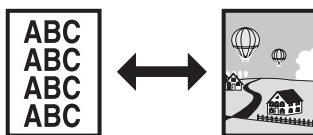
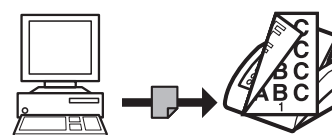

Image Quality
→ p.4-3

Print a document from a PC*1



Printing
→ p.5-2

*1 Indicates the features available only for FAX-L160.



Back



Previous



Next

TOP

Before Using the Machine 1

Document and Paper 2

Sending and Receiving 3

Copying 4

Printing (FAX-L160 Only) 5

System Manager Settings 6

Maintenance 7

Troubleshooting 8

Appendix 9

Table of Contents

Index

Table of Contents

Manuals for the Machine..... i

Things You Can Do..... ii

How to Use This GuideXV

 Using the Top Page..... xv

 Using the Chapter Topic List xvi

 Illustrations Used in This Manual..... xviii

Legal Noticesxix

1 Before Using the Machine 1-1

 Machine Components..... 1-3

 Operation Panel..... 1-6

 Operation Panel..... 1-6



Back



Previous



Next

TOP

Before Using the Machine 1

Document and Paper 2

Sending and Receiving 3

Copying 4

Printing (FAX-L160 Only) 5

System Manager Settings 6

Maintenance 7

Troubleshooting 8

Appendix 9

Table of Contents

Index

LCD (Standby Mode) 1-9

 Fax Mode..... 1-9

 Copy Mode 1-9

Optional Handset 1-10

 Maintaining the Handset 1-10

Toner Cartridge 1-11

 Maintaining the Toner Cartridge 1-12

Telephone Line Setting 1-13

 Setting the Telephone Line Type..... 1-13

Timer Settings 1-14

 Setting the Sleep Mode 1-14

 Setting Daylight Saving Time 1-15



Back



Previous



Next

TOP

Before Using the Machine 1

Document and Paper 2

Sending and Receiving 3

Copying 4

Printing (FAX-L160 Only) 5

System Manager Settings 6

Maintenance 7

Troubleshooting 8

Appendix 9

Table of Contents

Index

2 Document and Paper.....2-1

Document Requirements.....2-2

Scanning Area2-3

Loading Documents2-4

Paper Requirements.....2-5

Printable Area2-7

Loading Paper2-8

 Loading Envelopes2-8

Setting Paper Size and Type 2-11

3 Sending and Receiving.....3-1

Basic Sending Method3-5



Back



Previous



Next

TOP

Before Using the Machine 1

Document and Paper 2

Sending and Receiving 3

Copying 4

Printing (FAX-L160 Only) 5

System Manager Settings 6

Maintenance 7

Troubleshooting 8

Appendix 9

Table of Contents

Index

Scan Settings 3-6

- Image Quality 3-6
- Density 3-6

Storing/Editing Address Book 3-7

- Storing/Editing One-Touch Speed Dialing Keys/Coded Speed Dialing Codes 3-7
- Storing/Editing Group Dialing 3-10

Specifying Recipients 3-14

- Using One-Touch Speed Dialing Keys 3-14
- Using Coded Speed Dialing Codes 3-14
- Group Dialing 3-15
- Using Address Book Key 3-15

Manual Sending 3-17



Back



Previous



Next

TOP

Before Using the Machine 1

Document and Paper 2

Sending and Receiving 3

Copying 4

Printing (FAX-L160 Only) 5

System Manager Settings 6

Maintenance 7

Troubleshooting 8

Appendix 9

Table of Contents

Index

Fax Dialing Features 3-18

- Dialing Through a Switchboard 3-18
- Switching Temporarily to Tone Dialing 3-19
- Redialing 3-19
- Checking Dialing Line 3-21
- Dialing an Overseas Number (With Pauses)..... 3-21

Basic Receiving Method..... 3-23

Receiving Features..... 3-24

- FAX/TEL: Optional Settings..... 3-24
- Manual Reception..... 3-25
- Memory Reception..... 3-25
- Memory Lock Reception 3-26
- Remote Reception 3-27
- Selecting the Receive Mode for Printing..... 3-28
- Reception Restriction 3-29
- Printing Received Documents..... 3-29



Back



Previous



Next

TOP

Before Using the Machine 1

Document and Paper 2

Sending and Receiving 3

Copying 4

Printing (FAX-L160 Only) 5

System Manager Settings 6

Maintenance 7

Troubleshooting 8

Appendix 9

Table of Contents

Index

Advanced Features 3-30

Broadcasting 3-30

Delayed Sending 3-30

Polling 3-31

Relay 3-33

Canceling TX/RX Jobs 3-34

Checking and Deleting TX/RX Jobs 3-35

Checking Transmission/Reception Results 3-35

Checking and Deleting Fax Documents Stored in Memory 3-35

4 Copying 4-1

Basic Copying Method 4-2

Scan Settings 4-3

Image Quality 4-3

Density 4-3

Zoom Ratio 4-4



Back



Previous



Next

TOP

Before Using the Machine 1

Document and Paper 2

Sending and Receiving 3

Copying 4

Printing (FAX-L160 Only) 5

System Manager Settings 6

Maintenance 7

Troubleshooting 8

Appendix 9

Table of Contents

Index

Canceling Copy Jobs.....4-5

5 Printing (FAX-L160 Only).....5-1

Printing Documents.....5-2

Advanced Printing Features.....5-3

Collate Printing.....5-3

Checking and Deleting Jobs.....5-4

Checking and Deleting Print Jobs.....5-4

6 System Manager Settings.....6-1

Specifying the System Manager Settings.....6-2

Restricting Access to Destinations.....6-3

Confirming Entered Fax Numbers.....6-3

Restricting Redial.....6-3



Back



Previous



Next

TOP

Before Using the Machine 1

Document and Paper 2

Sending and Receiving 3

Copying 4

Printing (FAX-L160 Only) 5

System Manager Settings 6

Maintenance 7

Troubleshooting 8

Appendix 9

Table of Contents

Index

7 Maintenance7-1

Cleaning the Machine7-2

Exterior7-2

Interior7-2

Fuser Roller.....7-6

Scanning area.....7-6

Replacing the Toner Cartridge 7-8

Redistributing Toner7-8

Replacing the Toner Cartridge with a New One7-12

Transporting the Machine 7-17

8 Troubleshooting8-1

Clearing Jams8-3

Document Jams.....8-3

Paper Jams.....8-5



Back



Previous



Next

TOP

- Before Using the Machine 1
- Document and Paper 2
- Sending and Receiving 3
- Copying 4
- Printing (FAX-L160 Only) 5
- System Manager Settings 6
- Maintenance 7
- Troubleshooting 8
- Appendix 9

- LCD Messages..... 8-10
- Error Codes 8-16
- If <LOAD CORRECT PAPER> is displayed 8-18
 - Re-Loading the Paper..... 8-18
 - Changing the Paper Size Setting..... 8-18
- General Problems..... 8-19
- Paper Feeding Problems..... 8-20
- Sending/Receiving Problems 8-21
 - Sending Problems 8-21
 - Receiving Problems..... 8-24
- Copying Problems 8-30
- Printing Problems (FAX-L160 Only) 8-32
- Telephone Problems 8-35

- Table of Contents
- Index



Back



Previous



Next

TOP

Before Using the Machine 1

Document and Paper 2

Sending and Receiving 3

Copying 4

Printing (FAX-L160 Only) 5

System Manager Settings 6

Maintenance 7

Troubleshooting 8

Appendix 9

Table of Contents

Index

If a Power Failure Occurs..... 8-36

If You Cannot Solve a Problem 8-37

9 Appendix.....9-1

Machine Settings 9-3

Printing USER DATA LIST.....9-3

Accessing the Setting Menu9-3

Setting Menu 9-5

PAPER SETTINGS.....9-5

VOLUME CONTROL.....9-5

COMMON SETTINGS9-6

COPY SETTINGS9-6

FAX SETTINGS.....9-7

ADDRESS BOOK SET..... 9-11

PRINTER SETTINGS (FAX-L160 Only)..... 9-12

TIMER SETTINGS.....9-13



Back



Previous



Next

TOP

- Before Using the Machine **1**
- Document and Paper **2**
- Sending and Receiving **3**
- Copying **4**
- Printing (FAX-L160 Only) **5**
- System Manager Settings **6**
- Maintenance **7**
- Troubleshooting **8**
- Appendix **9**

Table of Contents

Index

- ADJUST./CLEANING..... 9-14
- REPORT SETTINGS..... 9-14
- SYSTEM SETTINGS 9-16
- Summary of Reports and Lists..... 9-18
- Printing Reports Automatically..... 9-19
 - TX REPORT 9-19
 - RX REPORT 9-20
 - ACTIVITY REPORT 9-21
- Printing Reports and Lists Manually..... 9-23
- Checking Remaining Memory..... 9-24
- Checking Print and Scan Counts 9-25
- Glossary 9-26
- Index..... 9-32



Back



Previous



Next

TOP

How to Use This Guide

■ Using the Top Page

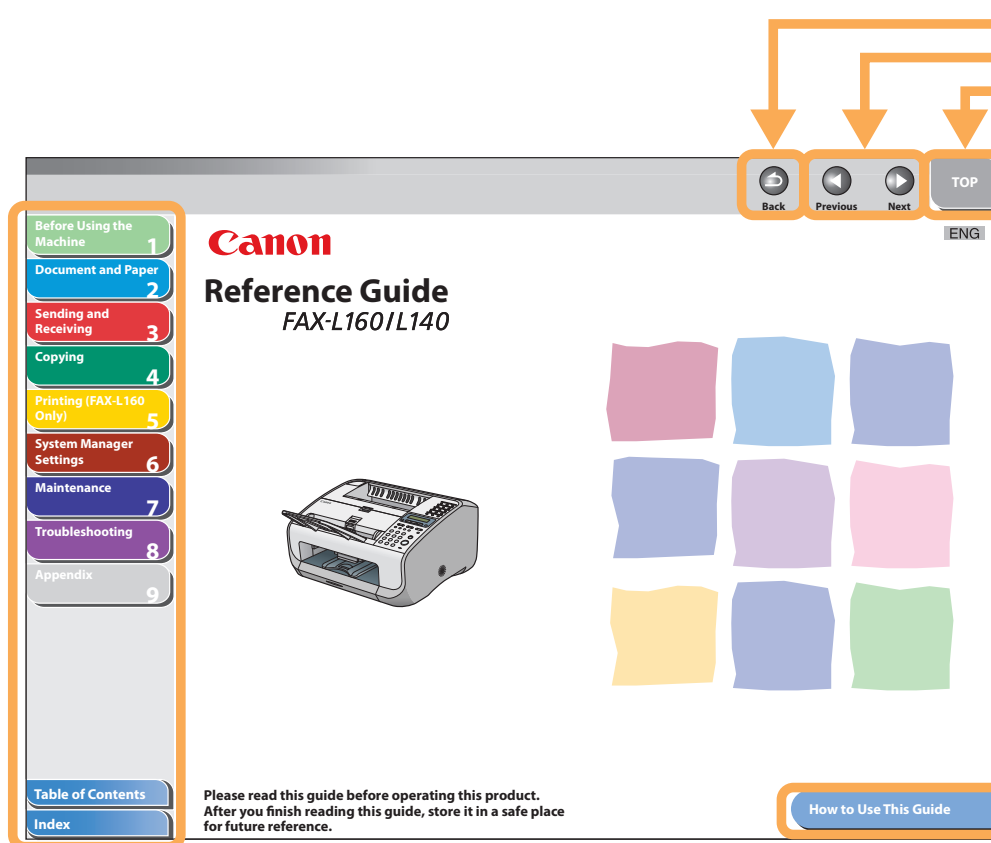

Returns to the last page opened.

Displays the previous or next page.

Returns to the top page.

Displays the "How to Use This Guide" page.

Quick links to the list of things you can do, topics for each chapter, table of contents, and the index.

Before Using the Machine 1

Document and Paper 2

Sending and Receiving 3

Copying 4

Printing (FAX-L160 Only) 5

System Manager Settings 6

Maintenance 7

Troubleshooting 8

Appendix 9

Table of Contents

Index



Back



Previous



Next

TOP

Before Using the Machine 1

Document and Paper 2

Sending and Receiving 3

Copying 4

Printing (FAX-L160 Only) 5

System Manager Settings 6

Maintenance 7

Troubleshooting 8

Appendix 9

Table of Contents

Index

Using the Chapter Topic List

Returns to the last page opened.
 Displays the previous or next page.
 Returns to the top page.

Back Previous Next TOP

1 Before Using the Machine

Machine Components	1-3
Operation Panel	1-6
Operation Panel.....	1-6
LCD (Standby Mode)	1-9
Fax Mode.....	1-9
Copy Mode.....	1-9
Optional Handset	1-10
Maintaining the Handset	1-10
Toner Cartridge	1-11
Maintaining the Toner Cartridge.....	1-12

Table of contents for the chapter.

Quick links to the list of things you can do, topics for each chapter, table of contents, and the index.

Table of Contents

Index



Back



Previous



Next

TOP

Before Using the Machine 1

Document and Paper 2

Sending and Receiving 3

Copying 4

Printing (FAX-L160 Only) 5

System Manager Settings 6

Maintenance 7

Troubleshooting 8

Appendix 9

Table of Contents

Index

The following symbols are used throughout the manuals for the machine and indicate the warnings, cautions and notes you should keep in mind when using the machine.



WARNING

Indicates a warning that may lead to death or serious injury if not observed.



CAUTION

Explains how to avoid actions that could injure you or damage your machine.



NOTE

Explains operating restrictions and how to avoid minor difficulties.

In addition, this guide uses distinctive notations to identify keys and information in the LCD:

- The keys you press appear in square brackets: [Stop/Reset].
- Information in the LCD appears in angle brackets: <LOAD PAPER>.
- The items appear on the PC (Menus, Menu commands, buttons etc.) in square brackets: [Save].



Back



Previous



Next

TOP

Before Using the Machine 1

Document and Paper 2

Sending and Receiving 3

Copying 4

Printing (FAX-L160 Only) 5

System Manager Settings 6

Maintenance 7

Troubleshooting 8

Appendix 9

Table of Contents

Index

■ Illustrations Used in This Manual

Unless otherwise mentioned, illustrations used in this manual are those taken when no optional equipment is attached to the FAX-L160.

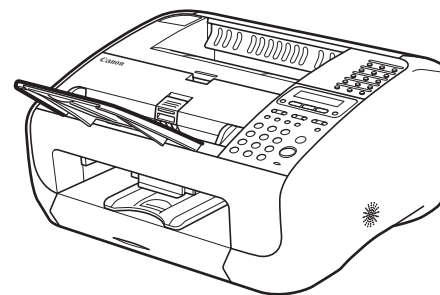

The model FAX-L160 is used for illustration purposes in this manual.

When there is any difference between FAX-L160 and FAX-L140, it is clearly indicated in the text, e.g., "FAX-L160 Only".



Back



Previous



Next

TOP

Before Using the Machine 1

Document and Paper 2

Sending and Receiving 3

Copying 4

Printing (FAX-L160 Only) 5

System Manager Settings 6

Maintenance 7

Troubleshooting 8

Appendix 9

Table of Contents

Index

Legal Notices

Trademarks

Canon and the Canon logo are trademarks of Canon Inc.

Microsoft, Windows, Windows Server and Windows Vista are trademarks or registered trademarks of Microsoft Corporation in the U.S. and/or other countries.

All other product and brand names are registered trademarks, trademarks or service marks of their respective owners.

Copyright

Copyright © 2007 by Canon Inc. All rights reserved. No part of this publication may be reproduced, transmitted, transcribed, stored in a retrieval system, or translated into any language or computer language in any form or by any means, electronic, mechanical, magnetic, optical, chemical, manual, or otherwise, without the prior written permission of Canon Inc.

Disclaimer

The information in this document is subject to change without notice.

CANON INC. MAKES NO WARRANTY OF ANY KIND WITH REGARD TO THIS MATERIAL, EITHER EXPRESS OR IMPLIED, EXCEPT AS PROVIDED HEREIN, INCLUDING WITHOUT LIMITATION, THEREOF, WARRANTIES AS TO MARKETABILITY, MERCHANTABILITY, FITNESS FOR A PARTICULAR PURPOSE OF USE OR NON-INFRINGEMENT. CANON INC. SHALL NOT BE LIABLE FOR ANY DIRECT, INCIDENTAL, OR CONSEQUENTIAL DAMAGES OF ANY NATURE, OR LOSSES OR EXPENSES RESULTING FROM THE USE OF THIS MATERIAL.



Back



Previous



Next

TOP

Before Using the Machine 1

Document and Paper 2

Sending and Receiving 3

Copying 4

Printing (FAX-L160 Only) 5

System Manager Settings 6

Maintenance 7

Troubleshooting 8

Appendix 9

Table of Contents

Index

1 Before Using the Machine

Machine Components	1-3
Operation Panel	1-6
Operation Panel.....	1-6
LCD (Standby Mode)	1-9
Fax Mode.....	1-9
Copy Mode	1-9
Optional Handset	1-10
Maintaining the Handset	1-10
Toner Cartridge	1-11
Maintaining the Toner Cartridge	1-12



Back



Previous



Next

TOP

Before Using the Machine 1

Document and Paper 2

Sending and Receiving 3

Copying 4

Printing (FAX-L160 Only) 5

System Manager Settings 6

Maintenance 7

Troubleshooting 8

Appendix 9

Table of Contents

Index

Telephone Line Setting 1-13

Setting the Telephone Line Type 1-13

Timer Settings 1-14

Setting the Sleep Mode 1-14

Setting Daylight Saving Time 1-15



Back



Previous



Next

TOP

Before Using the Machine 1

Document and Paper 2

Sending and Receiving 3

Copying 4

Printing (FAX-L160 Only) 5

System Manager Settings 6

Maintenance 7

Troubleshooting 8

Appendix 9

Machine Components

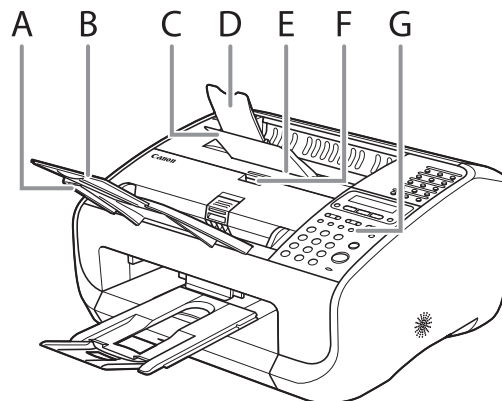

- A Document feeder tray
Holds documents.
- B Document feeder tray extension
Extension for the document feeder tray.
- C Paper delivery tray
Outputs printouts.
- D Paper delivery tray extension
Extension for the paper output tray.
- E Toner cover
Open it when replacing the toner cartridge or removing jammed paper.
- F Notch
Used to open the toner cover.
- G Operation panel
Controls the machine.

Table of Contents

Index



Back



Previous



Next

TOP

Before Using the Machine 1

Document and Paper 2

Sending and Receiving 3

Copying 4

Printing (FAX-L160 Only) 5

System Manager Settings 6

Maintenance 7

Troubleshooting 8

Appendix 9

Table of Contents

Index

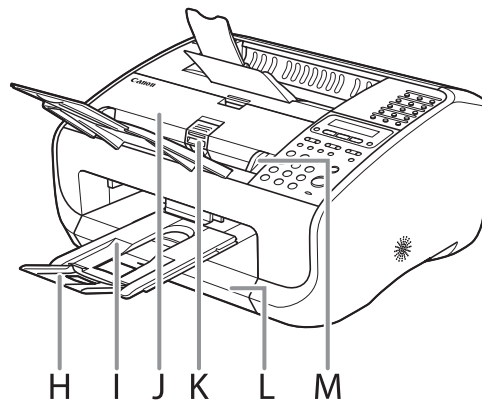

- H Document delivery tray extension
Extension for the document delivery tray.
- I Document delivery tray
Outputs scanned documents. Part of paper stack cover.
- J ADF (Automatic Document Feeder)
Feeds documents automatically into the machine for scanning.
- K Document release lever
Releases jammed document.
- L Paper stack cover
Protects paper supply in the machine from dirt and dust.
- M Document guides
Adjust to the width of documents.



Back



Previous



Next

TOP

Before Using the Machine 1

Document and Paper 2

Sending and Receiving 3

Copying 4

Printing (FAX-L160 Only) 5

System Manager Settings 6

Maintenance 7

Troubleshooting 8

Appendix 9

Table of Contents

Index

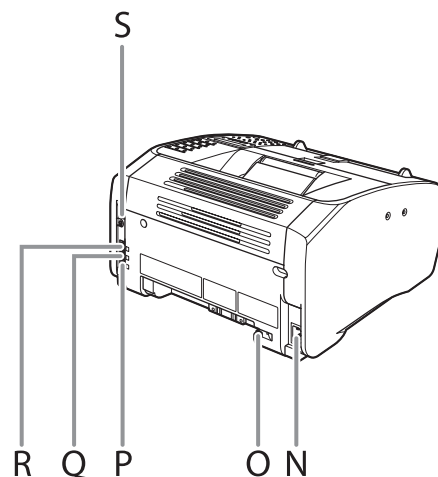

- N Power socket
Connect the power cord.
- O Handset cable retainer
Hook the optional handset cable to retain the slack.
- P Line jack
Connect the telephone cable.
- Q External device jack
Connect an external device if necessary.
- R Handset jack
Connect the optional handset.
- S USB port
Connect the USB cable.



Back



Previous



Next

- Before Using the Machine **1**
- Document and Paper **2**
- Sending and Receiving **3**
- Copying **4**
- Printing (FAX-L160 Only) **5**
- System Manager Settings **6**
- Maintenance **7**
- Troubleshooting **8**
- Appendix **9**
- Table of Contents
- Index

Operation Panel

■ Operation Panel

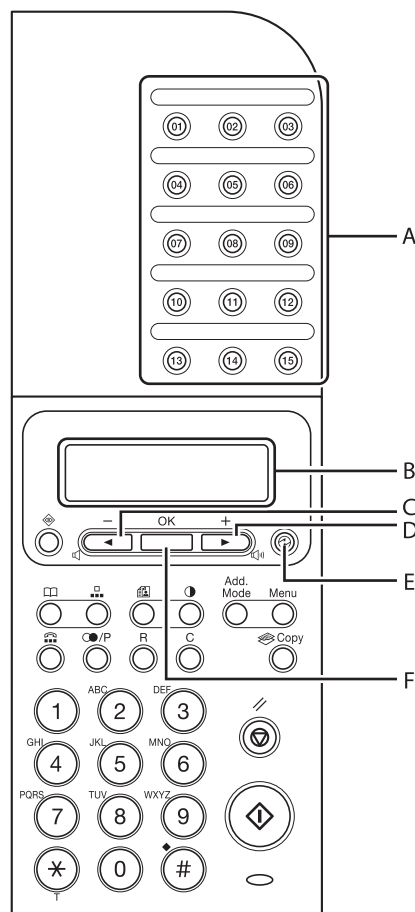

- A One-Touch Speed Dialing keys
Press to enter destinations registered for one-touch speed dialing or group dialing.
- B LCD display
Displays messages and prompts during operation. Also displays selections, text, and numbers when adjusting settings.
- C [←] key
Press to decrease the value for various settings. Also press to see the previous item in the menu.
- D [→] key
Press to increase the value for various settings. Also press to see the next item in the menu.
- E [Energy Saver] key
Press to set or cancel the Sleep mode manually. The key lights green when the Sleep mode is set, and goes off when the mode is canceled.
- F [OK] key
Press to accept a set function or mode.



Back



Previous



Next

TOP

Before Using the Machine 1

Document and Paper 2

Sending and Receiving 3

Copying 4

Printing (FAX-L160 Only) 5

System Manager Settings 6

Maintenance 7

Troubleshooting 8

Appendix 9

Table of Contents

Index

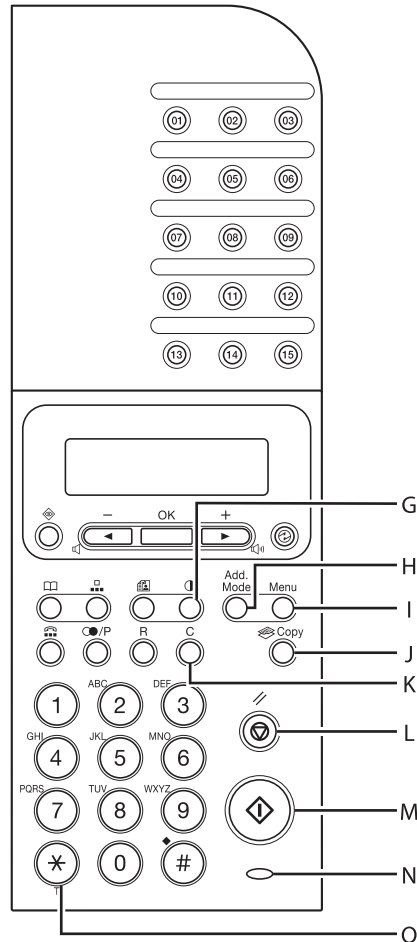

- G [Density] key
Press to adjust the density for copy or documents you send.
- H [Add. Mode] key
Press to access additional fax modes.
- I [Menu] key
Press to access the setting menu for customizing machine operations.
- J [Copy] key
Press to switch to the Copy mode.
- K [Clear] key
Press to clear entered alphanumeric characters.
- L [Stop/Reset] key
Press to stop a current job or to return the machine to the standby mode. Also, press to switch to the Fax mode when the machine is in the Copy mode.
- M [Start] key
Press to start scanning documents for sending or copying.
- N Processing/Data indicator
Flashes while sending or receiving faxes. Lights when the machine has waiting jobs and stores the data in memory.

NOTE

Please note that any fax documents that have been received and are stored in the memory will be deleted if you disconnect the power cord when the Processing/Data indicator is lit.

- O [Tone] key
Press to switch from rotary pulse to tone dialing.



Back



Previous



Next

TOP

Before Using the Machine 1

Document and Paper 2

Sending and Receiving 3

Copying 4

Printing (FAX-L160 Only) 5

System Manager Settings 6

Maintenance 7

Troubleshooting 8

Appendix 9

Table of Contents

Index

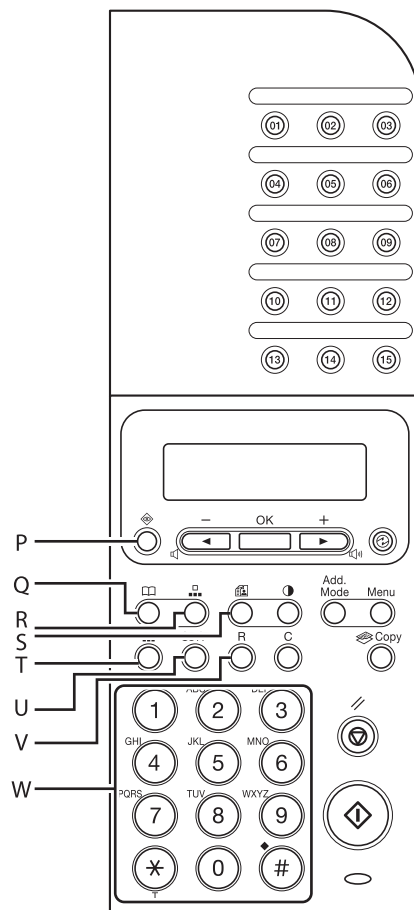

- P [System Monitor] key
Press to check the sending status, print status, sending/receiving log, available memory, or printing/scanning count.
- Q [Address Book] key
Press to search pre-registered destinations under one-touch speed dialing keys or coded speed dialing by name.
- R [Coded Dial] key
Press to specify recipients registered under coded speed dialing.
- S [Image Quality] key
Press to select image quality for copy or fax.
- T [Hook] key
Press when you want to dial without lifting up the handset of the optional telephone or external telephone.
- U [Redial/Pause] key
Press to redial the last dialed number, or press to insert a pause when entering a fax number.
- V [R] key
Enter when dialing an outside number through a switchboard.
- W Numeric keys
Use to enter letters and numbers.



Back



Previous



Next

TOP

Before Using the Machine 1

Document and Paper 2

Sending and Receiving 3

Copying 4

Printing (FAX-L160 Only) 5

System Manager Settings 6

Maintenance 7

Troubleshooting 8

Appendix 9

LCD (Standby Mode)

Fax Mode

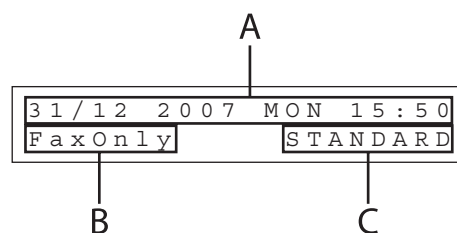

- A Date & Time
- B Receive mode
- C Image quality

Copy Mode

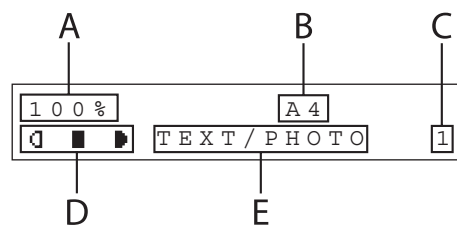

- A Zoom ratio
- B Paper size
- C Quantity
- D Density
- E Image quality

NOTE

- When you connect the power cord, the LCD displays <PLEASE WAIT> first, and then displays <INITIALIZING...> until the standby display appears. It is also possible to see the standby display without having <INITIALIZING...> shown.
- If the machine remains idle for one minute, the display returns to the standby mode. In that case, if the display shows the Copy mode, it will switch to the Fax mode.

Table of Contents

Index



Back



Previous



Next

TOP

Before Using the Machine 1

Document and Paper 2

Sending and Receiving 3

Copying 4

Printing (FAX-L160 Only) 5

System Manager Settings 6

Maintenance 7

Troubleshooting 8

Appendix 9

Table of Contents

Index

Optional Handset

If you want to use the machine as a telephone and a fax machine, or if you want to receive faxes manually, install the handset available from your local authorized Canon dealer or the Canon help line.

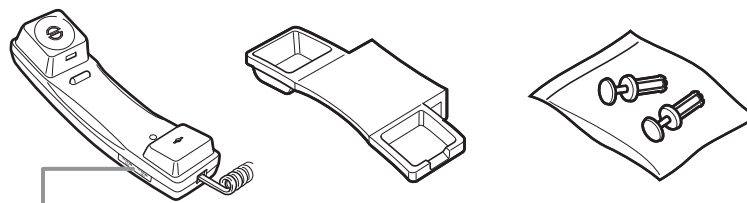

Use a sharp object (i.e., pen) to select the ring volume of the handset.



NOTE

For how to install the handset, see "Before FAX Setting," in the Starter Guide.

■ Maintaining the Handset

- Do not leave the handset exposed to direct sunlight.
- Do not install the handset in hot or humid conditions.
- Do not spray aerosol polish on the handset as it may cause damage.
- Use a damp cloth to wipe clean the handset.



Back



Previous



Next

TOP

Before Using the Machine 1

Document and Paper 2

Sending and Receiving 3

Copying 4

Printing (FAX-L160 Only) 5

System Manager Settings 6

Maintenance 7

Troubleshooting 8

Appendix 9

Table of Contents

Index

Toner Cartridge

The lifetime of the Canon Genuine toner cartridge used in this machine is approximately 2,000 pages. The page counts are based on 5% coverage* when printing A4 size paper with the default print density setting. The level of toner consumption varies depending on the type of documents printed. If your average document contains a lot of graphics, tables, or charts, the life of the toner cartridge will be shorter as they consume more toner. When you are replacing a toner cartridge, be sure to use a toner cartridge designed for this product. To purchase a new Canon genuine toner cartridge, contact your local authorized Canon dealer or Canon help line.

* The term "5% coverage" denotes a document on which the area covered with toner is 5% of the total area of a sheet.

Toner Cartridge name:
Canon FX10 Cartridge

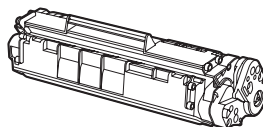

Model Name	Supported Canon Genuine Cartridge	Print Yield
FAX-L160 FAX-L140	Canon FX10 Cartridge	Approx. 2,000 pages



Back



Previous



Next

TOP

Before Using the Machine 1

Document and Paper 2

Sending and Receiving 3

Copying 4

Printing (FAX-L160 Only) 5

System Manager Settings 6

Maintenance 7

Troubleshooting 8

Appendix 9

Table of Contents

Index

■ Maintaining the Toner Cartridge

- Keep the toner cartridge away from computer screens, disk drives, and floppy disks. The magnet inside the toner cartridge may harm these items.
- Avoid locations subject to high temperature, high humidity, or rapid changes in temperature.
- Do not expose the toner cartridge to direct sunlight or bright light for more than five minutes.
- Store the toner cartridge in its protective bag. Do not open the bag until you are ready to install the toner cartridge in the machine.
- Save the toner cartridge's protective bag in case you need to repack and transport the toner cartridge at a later date.
- Do not store the toner cartridge in a salty atmosphere or where there are corrosive gases such as from aerosol sprays.
- Do not remove the toner cartridge from the machine unnecessarily.
- Do not open the drum protective shutter on the toner cartridge. Print quality may deteriorate if the drum surface is exposed to light or is damaged.
- Always hold the toner cartridge by its handle to avoid touching the drum protective shutter.
- Do not stand the toner cartridge on end, and do not turn it upside down. If toner becomes caked in the toner cartridge, it may become impossible to free it even by shaking the toner cartridge.
- If there is a toner powder leakage, make sure not to inhale or touch the toner powder. If it comes in contact with your skin, rinse with cold water using soap. If you feel an irritation on your skin or inhale the powder, consult a doctor immediately.
- When removing the toner cartridge from the machine, make sure to remove it carefully. If not removed with care, the toner powder may scatter and come in contact with your eyes and mouth. If this happens, rinse with water and consult a doctor immediately.
- Keep the toner cartridge away from small children. If they ingest the toner powder, consult a doctor immediately.
- Do not disassemble the toner cartridge. The toner powder may scatter and come in contact with your eyes and mouth. If this happens, rinse with water and consult a doctor immediately.



CAUTION

Do not place the toner cartridge in fire. Toner powder is flammable.



Back



Previous



Next

TOP

Before Using the Machine 1

Document and Paper 2

Sending and Receiving 3

Copying 4

Printing (FAX-L160 Only) 5

System Manager Settings 6

Maintenance 7

Troubleshooting 8

Appendix 9

Telephone Line Setting

■ Setting the Telephone Line Type

The default setting is <TOUCH TONE>.

1. Press [Menu].
2. Press [◀] or [▶] to select <FAX SETTINGS>, then press [OK].
3. Press [◀] or [▶] to select <USER SETTINGS>, then press [OK].
4. Press [◀] or [▶] to select <TEL LINE TYPE>, then press [OK].

5. Press [◀] or [▶] to select the telephone line type, then press [OK].

<TOUCH TONE>: Tone dialing

<ROTARY PULSE>: Pulse dialing



NOTE

If you do not know the type of telephone line you use, contact your local telephone company.

6. Press [Stop/Reset] to return to the standby mode.

Table of Contents

Index



Back



Previous



Next

TOP

Before Using the Machine 1

Document and Paper 2

Sending and Receiving 3

Copying 4

Printing (FAX-L160 Only) 5

System Manager Settings 6

Maintenance 7

Troubleshooting 8

Appendix 9

Timer Settings

■ Setting the Sleep Mode

When the machine remains idle for a certain period of time, it automatically enters the Sleep mode.

The default settings are <ON> and <5MIN.>.

1. Press [Menu].
2. Press [◀-] or [+▶] to select <TIMER SETTINGS>, then press [OK].
3. Press [◀-] or [+▶] to select <AUTO SLEEP>, then press [OK].
4. Press [◀-] or [+▶] to select <ON>, then press [OK].
5. Press [◀-] or [+▶] to select the desired interval, then press [OK].

You can set the interval from 3 to 30 minutes (in one-minute increments).

You can also enter values using numeric keys.



The default setting is 5 minutes.

6. Press [Stop/Reset] to return to the standby mode.



- [Energy Saver] lights green when the machine enters the Sleep mode.
- To resume the normal mode from the Sleep mode, press [Energy Saver] on the operation panel.
- To enter the Sleep mode manually, press [Energy Saver] on the operation panel.
- The machine will not enter the Sleep mode when:
 - the machine is in operation
 - the Processing/Data indicator lights or flashes
 - a message appears on the display
 - a paper jam occurs in the machine
 - the optional handset or the handset of the external telephone is off the hook
- The machine will leave the Sleep mode when:
 - you press [Energy Saver] on the operation panel
 - a fax is received
 - the optional handset or the handset of the external telephone is off the hook
 - a print job is sent from a computer, and the print is started

Table of Contents

Index



Back



Previous



Next

TOP

Before Using the Machine 1

Document and Paper 2

Sending and Receiving 3

Copying 4

Printing (FAX-L160 Only) 5

System Manager Settings 6

Maintenance 7

Troubleshooting 8

Appendix 9

Table of Contents

Index

■ Setting Daylight Saving Time

In some countries or areas, time is advanced throughout the summer season. This is called "Daylight Saving Time."

The default setting is <ON>.

1. Press [Menu].
2. Press [◀] or [▶] to select <TIMER SETTINGS>, then press [OK].
3. Press [◀] or [▶] to select <DAYLIGHT SV.TIME>, then press [OK].
4. Press [◀] or [▶] to select <ON>, then press [OK].
5. Press [◀] or [▶] to select <BEGIN DATE/TIME>, then press [OK].
6. Press [◀] or [▶] to select <MONTH>, then press [OK].
7. Press [◀] or [▶] to select the month, then press [OK].
8. Press [◀] or [▶] to select <WEEK>, then press [OK].
9. Press [◀] or [▶] to select the week, then press [OK].
10. Press [◀] or [▶] to select <DAY>, then press [OK].
11. Press [◀] or [▶] to select the day, then press [OK].
12. Press [Menu].
13. Press [◀] or [▶] to select <END DATE/TIME>, then press [OK].



Back



Previous



Next

TOP

Before Using the Machine 1

Document and Paper 2

Sending and Receiving 3

Copying 4

Printing (FAX-L160 Only) 5

System Manager Settings 6

Maintenance 7

Troubleshooting 8

Appendix 9

Table of Contents

Index

14. Press [**←**] or [**+**] to select <MONTH>, then press [OK].
15. Press [**←**] or [**+**] to select the month, then press [OK].
16. Press [**←**] or [**+**] to select <WEEK>, then press [OK].
17. Press [**←**] or [**+**] to select the week, then press [OK].
18. Press [**←**] or [**+**] to select <DAY>, then press [OK].
19. Press [**←**] or [**+**] to select the day, then press [OK].
20. Press [Stop/Reset] to return to the standby mode.



Back



Previous



Next

TOP

2 Document and Paper

Before Using the Machine 1

Document and Paper 2

Sending and Receiving 3

Copying 4

Printing (FAX-L160 Only) 5

System Manager Settings 6

Maintenance 7

Troubleshooting 8

Appendix 9

Table of Contents

Index

Document Requirements.....2-2

Scanning Area.....2-3

Loading Documents2-4

Paper Requirements2-5

Printable Area.....2-7

Loading Paper2-8

Loading Envelopes2-8

Setting Paper Size and Type2-11



Back



Previous



Next

TOP

- Before Using the Machine **1**
- Document and Paper **2**
- Sending and Receiving **3**
- Copying **4**
- Printing (FAX-L160 Only) **5**
- System Manager Settings **6**
- Maintenance **7**
- Troubleshooting **8**
- Appendix **9**
- Table of Contents
- Index

Document Requirements

Size (W x L)	Quantity (for 75 g/m ² paper)	Weight
Max. 216 x 400 mm	– Max. 30 A4- or Letter-size sheets	64 to 105 g/m ²
Min. 148 x 105 mm	– Max. 10 Legal-size sheets or the stack height of 5 mm	

NOTE

If using fine art paper, it should be 0.1 mm or thicker per sheet.

● **To prevent document jams, do not use any of the following:**

- Wrinkled or creased paper
- Carbon paper or carbon-backed paper
- Curled or rolled paper
- Coated paper
- Torn paper
- Onion skin or thin paper
- Documents with staples or paper clips attached
- Paper with fresh glue, ink, or correction fluid that is not completely dry



Back



Previous



Next

TOP

- Before Using the Machine 1
- Document and Paper 2
- Sending and Receiving 3
- Copying 4
- Printing (FAX-L160 Only) 5
- System Manager Settings 6
- Maintenance 7
- Troubleshooting 8
- Appendix 9

Scanning Area

Make sure your document's text and graphics fall within the shaded area in the following diagram. Note that the margin widths listed are approximate and there may be slight variations in actual use.

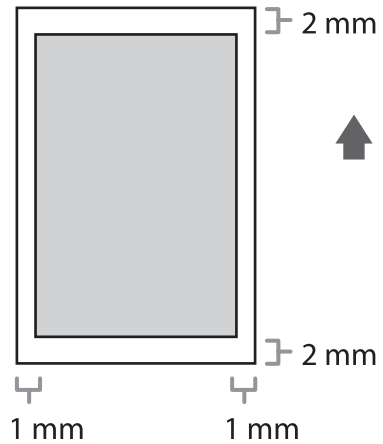

- Table of Contents
- Index



Back



Previous



Next

TOP

Before Using the Machine 1

Document and Paper 2

Sending and Receiving 3

Copying 4

Printing (FAX-L160 Only) 5

System Manager Settings 6

Maintenance 7

Troubleshooting 8

Appendix 9

Table of Contents

Index

Loading Documents

1. Adjust the slide guides to the width of the documents.

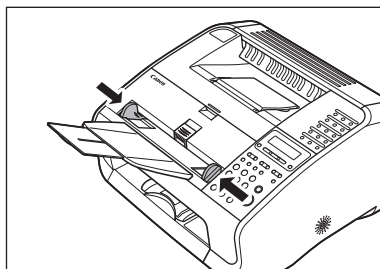

2. Fan the document stack and even the edges.

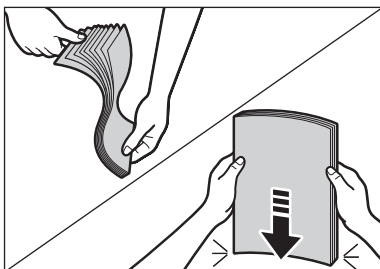

3. Insert the document top edge first in the ADF with the printed side facing up.

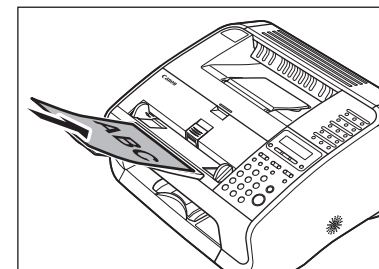

The document is ready for scanning.



Back



Previous



Next

TOP

Before Using the Machine 1

Document and Paper 2

Sending and Receiving 3

Copying 4

Printing (FAX-L160 Only) 5

System Manager Settings 6

Maintenance 7

Troubleshooting 8

Appendix 9

Paper Requirements

Paper Size Setting	Weight	Quantity
A4, B5*, A5*, Executive*, Envelope*(COM10, Monarch, DL, ISO-C5 (6 3/8" x 9" (162 x 229 mm)), Oficio, Brazil-Oficio, Mexico-Oficio, Folio, Government-LTR, Government- LGL, Foolscap, LTR, LGL, Custom paper* (3" x 5" to 8 1/2" x 14" (76 x 127 to 216 x 356 mm))	64 to 128 g/m ²	Max. stack height: 15 mm (Approx. 150 sheets of 80 g/m ² paper)

* Only for PC printing

Paper Type Setting	Paper Type	Weight
Plain Paper	Plain paper	64 to 90 g/m ²
Plain Paper L		
Heavy Paper	Heavy paper	105 to 128 g/m ²
Heavy Paper H		
Transparency	Transparencies	

NOTE

- The default paper size is A4. If you use a different paper size, you must change the paper size settings. (See "Setting Paper Size and Type," on p. 2-11.)
- For transparencies, you can load only up to 100 sheets.

● To prevent paper jams, do not use any of the following:

- Wrinkled or creased paper
- Curled or rolled paper
- Coated paper
- Torn paper
- Damp paper
- Very thin paper
- Paper which has been printed on using a thermal transfer printer (Do not copy on the reverse side.)

● The following types of paper do not print well:

- Highly textured paper
- Very smooth paper
- Shiny paper

Table of Contents

Index



Back



Previous



Next

TOP

Before Using the Machine 1

Document and Paper 2

Sending and Receiving 3

Copying 4

Printing (FAX-L160 Only) 5

System Manager Settings 6

Maintenance 7

Troubleshooting 8

Appendix 9

Table of Contents

Index

- Make sure the paper is free from dust, lint, and oil stains.
- Be sure to test paper before purchasing large quantities.
- Store all paper wrapped and on a flat surface until ready for use. Keep opened packs in their original packaging in a cool, dry location.
- Store paper at 18°C–24°C, 40%–60% relative humidity.
- Use only the transparencies designed for laser printers. Canon recommends you to use Canon type transparencies with this machine.



Back



Previous



Next

TOP

Before Using the Machine 1

Document and Paper 2

Sending and Receiving 3

Copying 4

Printing (FAX-L160 Only) 5

System Manager Settings 6

Maintenance 7

Troubleshooting 8

Appendix 9

Table of Contents

Index

Printable Area

The shaded area indicates the approximate printable area of A4 paper and envelope. Note that the margin widths listed are approximate and there may be slight variations in actual use.

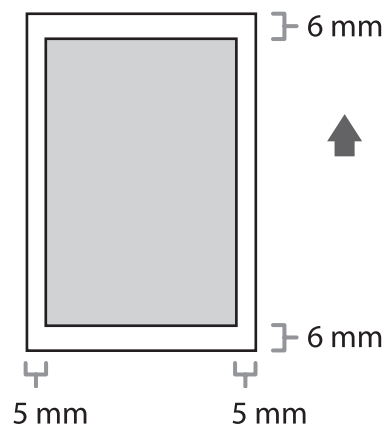



Back



Previous



Next

TOP

Before Using the Machine 1

Document and Paper 2

Sending and Receiving 3

Copying 4

Printing (FAX-L160 Only) 5

System Manager Settings 6

Maintenance 7

Troubleshooting 8

Appendix 9

Table of Contents

Index

Loading Paper

To load paper in the paper feeder, see “Set Up the Machine,” in the Starter Guide.

■ Loading Envelopes

● Use standard envelopes with diagonal seams and flaps.

- Make sure to set the correct envelope size in the printer driver. (See [Online Help](#).)

● To prevent jams, do not use the following:

- Envelopes with windows, holes, perforations, cutouts, and double flaps
- Envelopes made with special coated paper or deeply embossed paper
- Envelopes with peel-off sealing strips
- Envelopes with letters enclosed

1. Place the stack of envelopes on a firm, flat surface, and press down firmly on the edges to make the folds crisp.

Press all the way around the envelopes to remove any curls and expel air from inside the envelopes. Make sure that the stack is flat before loading it in the machine.

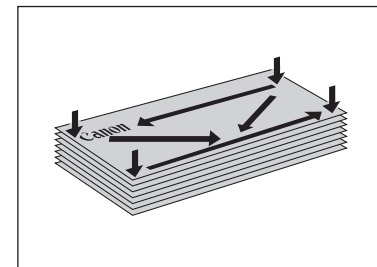



Back



Previous



Next

TOP

Before Using the Machine 1

Document and Paper 2

Sending and Receiving 3

Copying 4

Printing (FAX-L160 Only) 5

System Manager Settings 6

Maintenance 7

Troubleshooting 8

Appendix 9

Table of Contents

Index

2. Lift the paper stack cover and pull it out completely.

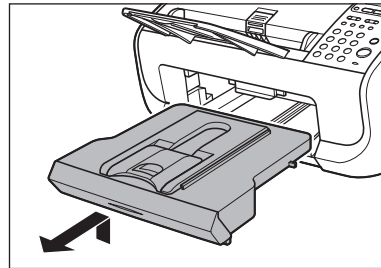

NOTE

Make sure the back end of the cover does not catch the front paper guide.

3. Pull out the paper guide rail.

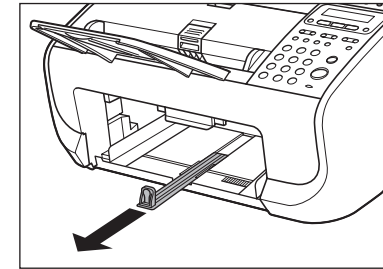

4. Insert the envelope stack with the print side facing up.

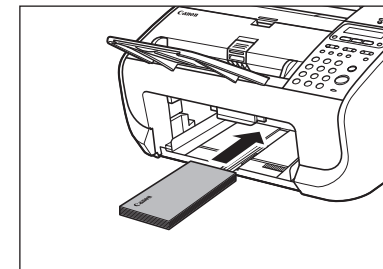



Back



Previous



Next

TOP

Before Using the Machine 1

Document and Paper 2

Sending and Receiving 3

Copying 4

Printing (FAX-L160 Only) 5

System Manager Settings 6

Maintenance 7

Troubleshooting 8

Appendix 9

Table of Contents

Index

- Adjust the side paper guides to the size of the stack.

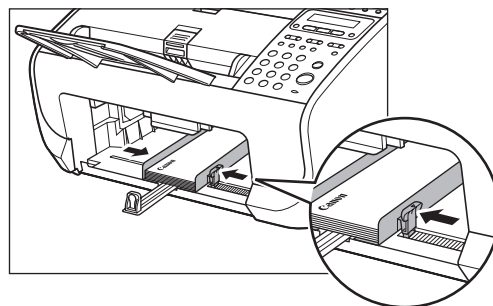

NOTE

If the paper guides are not adjusted correctly for the size of the envelopes, the quality of your printouts may be adversely affected.

- Push back the paper guide rail to the front edge of the stack.

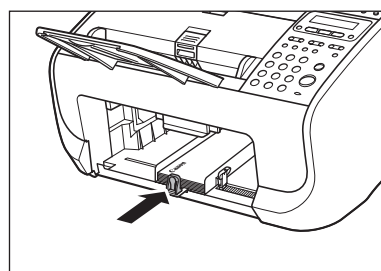

- Pinch and slide the front paper guide to match the envelope size.

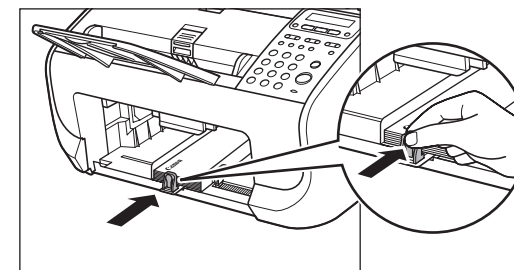

- Insert the paper stack cover.

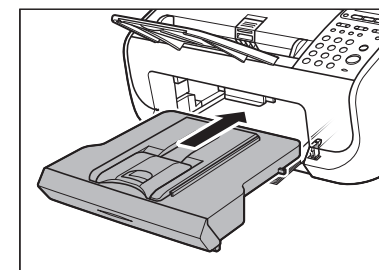

NOTE

Make sure the back end of the cover does not catch and lower the scanning platform.



Back



Previous



Next

TOP

Before Using the Machine 1

Document and Paper 2

Sending and Receiving 3

Copying 4

Printing (FAX-L160 Only) 5

System Manager Settings 6

Maintenance 7

Troubleshooting 8

Appendix 9

Setting Paper Size and Type

The default setting is <A4> and <PLAIN PAPER>. When you place other sizes and/or types of paper, follow this procedure to change the settings.

1. Press [Menu].
2. Press [◀] or [▶] to select <PAPER SETTINGS>, then press [OK].
3. Press [◀] or [▶] to select <CASSETTE>, then press [OK].
4. Press [◀] or [▶] to select <PAPER SIZE>, then press [OK].
5. Press [◀] or [▶] to select the paper size, then press [OK].

You can select from the following paper sizes:

<A4>, <OFICIO>, <BRAZIL-OFICIO>, <MEXICO-OFICIO>, <FOLIO>, <GOVERNMENT-LETTER>, <GOVERNMENT-LEGAL>, <FOOLSCAP>, <LTR>, <LGL>



NOTE

The available paper size will vary depending on the country where the unit was purchased.

6. Press [OK].

7. Press [◀] or [▶] to select <PAPER TYPE>, then press [OK].

8. Press [◀] or [▶] to select the paper type, then press [OK].

You can select from the following paper types:

<PLAIN PAPER> or <PLAIN PAPER L>*¹ for Plain paper (64 g/m² to 90 g/m²)

<HEAVY PAPER> or <HEAVY PAPER H>*² for Heavy paper (105 g/m² to 128 g/m²)

<TRANSPARENCY> for Transparency

*¹ If paper curls excessively when printed with <PLAIN PAPER> selected, select <PLAIN PAPER L>.

*² If print fixing is not sufficient when printed with <HEAVY PAPER> selected, select <HEAVY PAPER H>.

9. Press [Stop/Reset] to return to the standby mode.

Table of Contents

Index



Back



Previous



Next

TOP

3 Sending and Receiving

- Before Using the Machine 1
- Document and Paper 2
- Sending and Receiving 3**
- Copying 4
- Printing (FAX-L160 Only) 5
- System Manager Settings 6
- Maintenance 7
- Troubleshooting 8
- Appendix 9

- Basic Sending Method3-5**
- Scan Settings3-6**
 - Image Quality3-6
 - Density3-6
- Storing/Editing Address Book.....3-7**
 - Storing/Editing One-Touch Speed Dialing Keys/
Coded Speed Dialing Codes3-7
 - Storing/Editing Group Dialing 3-10

- Table of Contents
- Index



Back



Previous



Next

TOP

Before Using the Machine 1

Document and Paper 2

Sending and Receiving 3

Copying 4

Printing (FAX-L160 Only) 5

System Manager Settings 6

Maintenance 7

Troubleshooting 8

Appendix 9

Table of Contents

Index

Specifying Recipients.....3-14

Using One-Touch Speed Dialing Keys 3-14

Using Coded Speed Dialing Codes..... 3-14

Group Dialing 3-15

Using Address Book Key 3-15

Manual Sending3-17

Fax Dialing Features.....3-18

Dialing Through a Switchboard..... 3-18

Switching Temporarily to Tone Dialing 3-19

Redialing 3-19

Checking Dialing Line 3-21

Dialing an Overseas Number (With Pauses)..... 3-21

Basic Receiving Method.....3-23



Back



Previous



Next

TOP

Before Using the Machine 1

Document and Paper 2

Sending and Receiving 3

Copying 4

Printing (FAX-L160 Only) 5

System Manager Settings 6

Maintenance 7

Troubleshooting 8

Appendix 9

Table of Contents

Index

Receiving Features3-24

FAX/TEL: Optional Settings..... 3-24

Manual Reception..... 3-25

Memory Reception..... 3-25

Memory Lock Reception 3-26

Remote Reception 3-27

Selecting the Receive Mode for Printing 3-28

Reception Restriction 3-29

Printing Received Documents..... 3-29

Advanced Features.....3-30

Broadcasting..... 3-30

Delayed Sending 3-30

Polling 3-31

Relay 3-33



Back



Previous



Next

TOP

- Before Using the Machine 1
- Document and Paper 2
- Sending and Receiving 3
- Copying 4
- Printing (FAX-L160 Only) 5
- System Manager Settings 6
- Maintenance 7
- Troubleshooting 8
- Appendix 9

- Table of Contents
- Index

- Canceling TX/RX Jobs.....3-34**
- Checking and Deleting TX/RX Jobs.....3-35**
 - Checking Transmission/Reception Results 3-35
 - Checking and Deleting Fax Documents
Stored in Memory 3-35



Back



Previous



Next

TOP

Before Using the Machine 1

Document and Paper 2

Sending and Receiving 3

Copying 4

Printing (FAX-L160 Only) 5

System Manager Settings 6

Maintenance 7

Troubleshooting 8

Appendix 9

Table of Contents

Index

Basic Sending Method

Follow this procedure to send faxes.

- 1. Make sure the LCD shows the fax mode. If the LCD shows the copy mode, press [Stop/Reset].**
- 2. Set documents.**
Insert the document top edge first in the ADF with the printed side facing up. (See "Loading Documents," on p. 2-4.)
- 3. Enter the fax number with the numeric keys.**
You can also specify the fax number with one-touch speed dialing keys, coded speed dialing codes, or [Address Book] key. (See "Specifying Recipients," on p. 3-14.)
- 4. Press [Start].**



Back



Previous



Next

- Before Using the Machine 1
- Document and Paper 2
- Sending and Receiving 3
- Copying 4
- Printing (FAX-L160 Only) 5
- System Manager Settings 6
- Maintenance 7
- Troubleshooting 8
- Appendix 9
- Table of Contents
- Index

Scan Settings

You can adjust the image quality and density of the document you send. The higher image quality you set, the better the output will be, but the longer the transmission will take.



NOTE

These settings return to the default values after all documents are scanned. If you want to keep the settings, set the density and/or image quality as following;
[Menu] → <FAX SETTINGS> → <USER SETTINGS> → <STANDARD SETTINGS> → <DENSITY> or <IMAGE QUALITY>
(See "Setting Menu," on p. 9-5.)

■ Image Quality

The default setting is <STANDARD>.

1. Press [Image Quality].
2. Press [←] or [→] to select the resolution, then press [OK].
 - <STANDARD>: for most text-only documents (200 x 100 dpi)
 - <FINE>: for fine-print documents (the resolution is twice that of <STANDARD>) (200 x 200 dpi)
 - <PHOTO>: for documents that contain photographs (the resolution is twice that of <STANDARD>) (200 x 200 dpi)
 - <SUPER FINE>: for documents that contain fine print and images (the resolution is four times that of <STANDARD>) (200 x 400 dpi)

■ Density

The default setting is (5).

1. Press [Density].
2. Press [←] or [→] to adjust the density, then press [OK].

Ex.



[←]: to make dark documents lighter.
[→]: to make light documents darker.



Back



Previous



Next

TOP

Before Using the Machine 1

Document and Paper 2

Sending and Receiving 3

Copying 4

Printing (FAX-L160 Only) 5

System Manager Settings 6

Maintenance 7

Troubleshooting 8

Appendix 9

Storing/Editing Address Book

This machine provides you with various ways to specify the fax/telephone numbers besides using the numeric keys. You can register fax/telephone numbers to the Address Book. Once you have registered fax/telephone numbers using this function, you can specify the fax/telephone numbers by simply pressing one or a combination of keys:

- **Using One-Touch Speed Dialing Keys (p. 3-14)**

You can specify fax/telephone numbers by pressing one-touch speed dialing keys. You can register up to 15 one-touch speed dialing keys, including group dialing.

- **Using Coded Speed Dialing (p. 3-14)**

You can specify fax/telephone numbers by pressing [Coded Dial] followed by two-digit code. You can register up to 100 coded speed dialing codes.

- **Using Group Dialing (p. 3-15)**

You can specify up to 15 groups of fax/telephone numbers registered in one-touch speed dialing keys. You can register up to 50 fax/telephone numbers in a group.

- **Using Address Book Key (p. 3-15)**

You can specify fax/telephone numbers by pressing [Address Book] and searching a fax/telephone number from Address Book.

■ Storing/Editing One-Touch Speed Dialing Keys/Coded Speed Dialing Codes

Registering One-Touch Speed Dialing Keys/Coded Speed Dialing Codes

1. Press [Menu].
2. Press [◀-] or [+▶] to select <ADDRESS BOOK SET.>, then press [OK].
3. Press [◀-] or [+▶] to select <1-TOUCH SPD DIAL> or <CODED DIAL>, then press [OK].
4. Press [◀-] or [+▶] to select a one-touch speed dialing key (01 to 15) or coded speed dialing code (00-99) for which you want to register the fax/telephone numbers, then press [OK].

You can also select a one-touch speed dialing key or coded speed dialing code by pressing the corresponding one-touch speed dialing key, or [Coded Dial] followed by the desired two-digit code.

Table of Contents

Index



Back



Previous



Next

TOP

Before Using the Machine 1

Document and Paper 2

Sending and Receiving 3

Copying 4

Printing (FAX-L160 Only) 5

System Manager Settings 6

Maintenance 7

Troubleshooting 8

Appendix 9

Table of Contents

Index

- 5. Enter the recipient name (max. 20 characters, including spaces) with the numeric keys, then press [OK].

Ex.

N A M E	[A]
C a n	

If you do not want to register the recipient name, press [OK] again to proceed to the next.

- 6. Enter the fax/telephone number you register (max. 50 digits, including spaces and pauses) with the numeric keys, then press [OK].

Ex.

T E L N U M B E R E N T R Y
0 1 2 X X X X X X X _

- Press [R] first if the machine is behind a switchboard. ("Dialing Through a Switchboard," on p. 3-18.)
- Press [Redial/Pause] to enter a pause. (See "Dialing an Overseas Number (With Pauses)," on p. 3-21.)

- 7. Press [◀] or [▶] to select <ON>, then press [OK].

If no subaddress or password is required, press [◀] or [▶] to select <OFF>, then press [OK]. And press [Stop/Reset] to return to the standby mode.

- 8. Enter the subaddress number you register (max. 20 digits) with the numeric keys, then press [OK].

If you want to attach a subaddress to your send job, make sure that the recipient's fax machine supports ITU-T standard subaddresses.

Ex.

S U B A D D R E S = 1 2 3 4 _

- 9. Enter the password you register (max. 20 digits) with the numeric keys, then press [OK].

Ex.

P A S S W O R D = 5 6 7 8 _

- 10. Press [Stop/Reset] to return to the standby mode.



Back



Previous



Next

TOP

Before Using the Machine 1

Document and Paper 2

Sending and Receiving 3

Copying 4

Printing (FAX-L160 Only) 5

System Manager Settings 6

Maintenance 7

Troubleshooting 8

Appendix 9

Table of Contents

Index

Editing One-Touch Speed Dialing Keys/Coded Speed Dialing Codes

1. Press [Menu].
2. Press [◀] or [▶] to select <ADDRESS BOOK SET.>, then press [OK].
3. Press [◀] or [▶] to select <1-TOUCH SPD DIAL> or <CODED DIAL>, then press [OK].
4. Press [◀] or [▶] to select the one-touch speed dialing key (01 to 15) or coded speed dialing code (00 to 99) you want to edit, then press [OK].
You can also select a one-touch speed dialing key or coded speed dialing code by pressing the corresponding one-touch speed dialing key, or [Coded Dial] followed by the two-digit code.
5. Press [▶] repeatedly to go to the character you want to change, then press [Clear].
To delete the entire entry, press and hold [Clear].
6. Enter a new character with the numeric keys, then press [OK].

7. Press [▶] repeatedly to go to the wrong digit, then press [Clear] to delete it.
To delete the entire entry, press and hold [Clear].
8. Enter a new number with the numeric keys, then press [OK].
9. If you want to change or enter the subaddress, press [◀] or [▶] to select <ON>, then press [OK].
If no subaddress is required, skip to step 14.
10. Press [▶] repeatedly to go to the digit you want to change, then press [Clear] to delete it.
11. Enter a new subaddress with the numeric keys, then press [OK].
12. Press [▶] repeatedly to go to the digit you want to change, then press [Clear] to delete it.
13. Enter a new password with the numeric keys, then press [OK].
14. Press [Stop/Reset] to return to the standby mode.



Back



Previous



Next

TOP

Before Using the Machine 1

Document and Paper 2

Sending and Receiving 3

Copying 4

Printing (FAX-L160 Only) 5

System Manager Settings 6

Maintenance 7

Troubleshooting 8

Appendix 9

Table of Contents

Index

Deleting One-Touch Speed Dialing Keys/Coded Speed Dialing Codes

1. Press [Menu].
2. Press [◀-] or [+▶] to select <ADDRESS BOOK SET.>, then press [OK].
3. Press [◀-] or [+▶] to select <1-TOUCH SPD DIAL> or <CODED DIAL>, then press [OK].
4. Press [◀-] or [+▶] to select the one-touch speed dialing key (01 to 15) or coded speed dialing code (00 to 99) you want to delete, then press [OK].
You can also select a one-touch speed dialing key or coded speed dialing code by pressing the corresponding one-touch speed dialing key, or [Coded Dial] followed by the two-digit code.
5. Press [OK].
6. Press and hold [Clear] to delete the entire entry, then press [OK].



If you delete the fax number, the registered name is cleared automatically.

7. Press [Stop/Reset] to return to the standby mode.

Storing/Editing Group Dialing



The recipients must be registered in one-touch speed dialing keys, or coded speed dialing codes beforehand.

Registering Group Dialing

1. Press [Menu].
2. Press [◀-] or [+▶] to select <ADDRESS BOOK SET.>, then press [OK].
3. Press [◀-] or [+▶] to select <GROUP DIAL>, then press [OK].
4. Press [◀-] or [+▶] to select an empty one-touch speed dialing key that you want to set as the group address, then press [OK].

You can also select a one-touch speed dialing key by pressing the corresponding one-touch speed dialing key.



Back



Previous



Next

TOP

Before Using the Machine 1

Document and Paper 2

Sending and Receiving 3

Copying 4

Printing (FAX-L160 Only) 5

System Manager Settings 6

Maintenance 7

Troubleshooting 8

Appendix 9

Table of Contents

Index

5. Enter the group name (max. 20 characters, including spaces) with the numeric keys, then press [OK].

To register another group, repeat the procedure from step 4.

Ex.

NAME	[A]
Canon Group	

6. Select the recipients you want to register in the group (max. 50 destinations) until all destinations are registered, then press [OK].

To enter a recipient stored under a one-touch speed dialing key, press the desired one-touch speed dialing key.

To enter a recipient stored under a coded speed dialing code, press [Coded Dial], then enter the two-digit code with the numeric keys. For multiple entries, press [Coded Dial] between each entry.



You can review the destinations which have been already entered with [◀] or [▶].

7. Press [Stop/Reset] to return to the standby mode.

Adding New Recipients to Group

1. Press [Menu].
2. Press [◀] or [▶] to select <ADDRESS BOOK SET.>, then press [OK].
3. Press [◀] or [▶] to select <GROUP DIAL>, then press [OK].
4. Press [◀] or [▶] to select a group to edit, then press [OK].
You can specify a group to edit by pressing the corresponding one touch speed dialing key.
5. Press [OK].
6. Select the recipient you want to add to the group, then press [OK].
For details on specifying a recipient from Address Book, see "Registering Group Dialing," on p. 3-10.
7. Press [Stop/Reset] to return to the standby mode.



Back



Previous



Next

TOP

Before Using the Machine 1

Document and Paper 2

Sending and Receiving 3

Copying 4

Printing (FAX-L160 Only) 5

System Manager Settings 6

Maintenance 7

Troubleshooting 8

Appendix 9

Table of Contents

Index

Deleting Recipients from Group

1. Press [Menu].
2. Press [◀-] or [+▶] to select <ADDRESS BOOK SET.>, then press [OK].
3. Press [◀-] or [+▶] to select <GROUP DIAL>, then press [OK].
4. Press [◀-] or [+▶] to select a group to edit, then press [OK].
You can specify a group to edit by pressing the corresponding one touch speed dialing key.
5. Press [OK].
6. Press [◀-] or [+▶] to display the recipient you want to delete from the group, then press [Clear].
Repeat this step if you want to delete another recipient.
7. Press [OK].
8. Press [Stop/Reset] to return to the standby mode.

Changing Group Name

1. Press [Menu].
2. Press [◀-] or [+▶] to select <ADDRESS BOOK SET.>, then press [OK].
3. Press [◀-] or [+▶] to select <GROUP DIAL>, then press [OK].
4. Press [◀-] or [+▶] to select a group to edit, then press [OK].
You can specify a group to edit by pressing the corresponding one touch speed dialing key.
5. Press [+▶] repeatedly to go to the character you want to change, then press [Clear].
To delete the entire name, press and hold [Clear].
6. Enter a new character with the numeric keys, then press [OK].
7. Press [OK].
8. Press [Stop/Reset] to return to the standby mode.



Back



Previous



Next

TOP

Before Using the Machine 1

Document and Paper 2

Sending and Receiving 3

Copying 4

Printing (FAX-L160 Only) 5

System Manager Settings 6

Maintenance 7

Troubleshooting 8

Appendix 9

Table of Contents

Index

Deleting Group Dialing

1. Press [Menu].
2. Press [◀] or [▶] to select <ADDRESS BOOK SET.>, then press [OK].
3. Press [◀] or [▶] to select <GROUP DIAL>, then press [OK].
4. Press [◀] or [▶] to select a group to delete, then press [OK].

You can specify a group to edit by pressing the corresponding one touch speed dialing key.

5. Press [OK].

6. Press [Clear] repeatedly until all recipients are deleted, then press [OK].



NOTE

- When you delete all recipients, the registered name is cleared automatically.
- If you press [Clear] excessively, the display returns to <ADDRESS BOOK>, and the recipients are left undeleted. Repeat the procedure from step 2.

7. Press [Stop/Reset] to return to the standby mode.



Back



Previous



Next

TOP

Before Using the Machine 1

Document and Paper 2

Sending and Receiving 3

Copying 4

Printing (FAX-L160 Only) 5

System Manager Settings 6

Maintenance 7

Troubleshooting 8

Appendix 9

Table of Contents

Index

Specifying Recipients

Follow the procedure below to send documents to registered recipients.

■ Using One-Touch Speed Dialing Keys

You can specify up to 15 recipients using one-touch speed dialing keys.



To use this feature, you must register recipients in one-touch speed dialing keys beforehand. (See "Storing/Editing Address Book," on p. 3-7.)

1. Set documents.

If you want to adjust the image quality and density, see "Scan Settings," on p. 3-6.

2. Press the desired one-touch speed dialing keys (01 to 15).

If you pressed a wrong key, press [Stop/Reset] and try again.

Ex.

```
☎ = 0 1 2 3 X X X X X X X X X
[ 0 5 ] C A N O N
```

3. Press [Start].

■ Using Coded Speed Dialing Codes

You can specify up to 100 recipients using coded speed dialing codes.



To use this feature, you must register recipients in coded speed dialing codes beforehand. (See "Storing/Editing Address Book," on p. 3-7.)

1. Set documents.

If you want to adjust the image quality and density, see "Scan Settings," on p. 3-6.

2. Press [Coded Dial].

3. Enter the desired two-digit code (00 to 99) with the numeric keys.

Ex.

```
☎ = 0 1 2 X X X X X X X X X
[ * 0 1 ] C A N O N
```

If you entered a wrong code, press [Stop/Reset], then try again from step 2.

4. Press [Start].



Back



Previous



Next

TOP

Before Using the Machine 1

Document and Paper 2

Sending and Receiving 3

Copying 4

Printing (FAX-L160 Only) 5

System Manager Settings 6

Maintenance 7

Troubleshooting 8

Appendix 9

Table of Contents

Index

■ Group Dialing



NOTE

To use this feature, you must register recipients in a group dialing beforehand. (See "Storing/Editing Address Book," on p. 3-7.)

1. Set documents.

If you want to adjust the image quality and density, see "Scan Settings," on p. 3-6.

2. Press the one-touch speed dialing key (01 to 15) under which the desired group dialing is registered.

If you pressed a wrong key, press [Stop/Reset], and perform step 2 again.

3. Press [Start].

■ Using Address Book Key

Address Book search enables you to search for a particular recipient registered in the machine. This is useful when you forget which one-touch speed dialing key or coded speed dialing code the recipient you want is registered under.

You can either go through all the recipients registered in the machine (<LIST>), or look up a particular one by their name (<SEARCH>).



NOTE

To use this feature, you must register destinations in Address Book beforehand. (See "Storing/Editing Address Book," on p. 3-7.)

Listing All Recipients

1. Set documents.

If you want to adjust the image quality and density, see "Scan Settings," on p. 3-6.

2. Press [Address Book].

If no recipient is registered for speed dialing, <NOT REGISTERED> is displayed.

3. Press [◀-] or [+▶] to select <LIST>, then press [OK].



Back



Previous



Next

TOP

Before Using the Machine 1

Document and Paper 2

Sending and Receiving 3

Copying 4

Printing (FAX-L160 Only) 5

System Manager Settings 6

Maintenance 7

Troubleshooting 8

Appendix 9

Table of Contents

Index

4. Press [**←**] or [**+**] to find the required recipient.
 - The recipients are listed in the order of one-touch speed dialing keys (01 to 15), and coded speed dialing codes (00 to 99).
 - For a one-touch speed dialing key or coded speed dialing code with no recipient name registered, their fax number is displayed.

5. Press [Start] to start dialing the displayed recipient.

Looking Up a Recipient

1. **Set documents.**
If you want to adjust the image quality and density, see "Scan Settings," on p. 3-6.
2. **Press [Address Book].**
If no recipient is registered for speed dialing, <NOT REGISTERED> is displayed.
3. Press [**←**] or [**+**] to select <SEARCH>, then press [OK].

4. Use the numeric keys to enter up to 10 first characters of the recipient's name, then press [OK].

Ex.

S E A R C H	[A]
C A N O N	

- Press [*****] to switch between input modes:
 - [A]: Letter mode
 - [1]: Number mode
- When the search is complete, the number of recipients that match the characters you entered is displayed in parentheses.
- Press [Clear] to run a new search.

5. Press [**←**] or [**+**] to find the required recipient.
 - [**←**]: displays recipients in order of registration.
 - [**+**]: displays recipients in reverse order.
6. When the recipient's name is displayed, press [Start].



Back



Previous



Next

- Before Using the Machine 1
- Document and Paper 2
- Sending and Receiving 3
- Copying 4
- Printing (FAX-L160 Only) 5
- System Manager Settings 6
- Maintenance 7
- Troubleshooting 8
- Appendix 9

Manual Sending

Use manual sending when you want to talk to the recipient before sending a document, or if the recipient does not have a fax machine that can receive automatically.



You cannot use group dialing for manual sending.

- 1. Connect the optional handset or an external telephone to the machine if you want to talk to the recipient before sending a document.**

For details on how to connect the optional handset or an external telephone to the machine, see "Connect Telephone Cables" and "Install Optional Handset," in the Starter Guide.

- 2. Set documents.**

If you want to adjust the image quality and density, see "Scan Settings," on p. 3-6.

- 3. Press [Hook] or pick up the optional handset or handset of your external telephone.**

- 4. Dial the recipient's fax/telephone number.**



Make sure to confirm the dial tone before entering a fax number. If you enter the number before the dial tone can be heard, the call may not connect, or the wrong number may be dialed.

- 5. Talk through the handset to the recipient.**

If you press [Hook] in step 3, you can pick up the handset when you hear the recipient's voice.

If you hear a high-pitched signal instead of the recipient's voice, go to step 7.

- 6. Ask the recipient to set their fax machine to receive faxes.**

- 7. When you hear a high-pitched signal, press [Start], then hang up the handset.**



Back



Previous



Next

TOP

Before Using the Machine 1

Document and Paper 2

Sending and Receiving 3

Copying 4

Printing (FAX-L160 Only) 5

System Manager Settings 6

Maintenance 7

Troubleshooting 8

Appendix 9

Table of Contents

Index

Fax Dialing Features

■ Dialing Through a Switchboard

If your machine is connected to a PBX, register the [R] key so you can easily access the outside line.

Registering the [R] Key

1. Press [Menu].
2. Press [◀] or [▶] to select <SYSTEM SETTINGS>, then press [OK].
3. Press [◀] or [▶] to select <COMMUNICATIONS>, then press [OK].
4. Press [◀] or [▶] to select <R-KEY SETTING>, then press [OK].
5. Press [◀] or [▶] to select <PBX>, then press [OK].

6. Use the numeric keys to enter the prefix number (up to 20 digits), then press [OK].

Ex.

P R E F I X
—

7. Press [Stop/Reset] to return to the standby mode.

Dialing using the [R] Key

1. Set documents.
2. Press [R] to access the outside line.
3. Use the numeric keys to enter the fax number.
4. Press [Start].



Back



Previous



Next

- Before Using the Machine 1
- Document and Paper 2
- Sending and Receiving 3
- Copying 4
- Printing (FAX-L160 Only) 5
- System Manager Settings 6
- Maintenance 7
- Troubleshooting 8
- Appendix 9

■ Switching Temporarily to Tone Dialing

If your machine is set for pulse dialing, use the procedure below to switch to tone dialing to use information services (e.g., banks, airline reservations, and hotel reservations).



NOTE

To talk to the other party, you will need to connect the optional handset or an external telephone to the machine.

1. Press [Hook].

You can also lift the handset instead.



NOTE

Make sure to confirm the dial tone before entering a fax number. If you enter the number before the dial tone can be heard, the call may not be connected, or the wrong number may be dialed.

2. Use the numeric keys to dial the required information service.

3. When the recorded message of the information service answers, press [Tone] to switch to tone dialing.

If you pressed [Hook] in step 1, you can pick up the handset to talk to the other party.

4. Use the numeric keys to enter the numbers requested by the information service.

5. If you want to receive faxes, press [Start].

- If you are using the external telephone, hang up the handset after pressing [Start].
- If you are using the optional handset, hang up to disconnect the call.

■ Redialing

Redialing can be done manually or automatically. For automatic redialing, you can set how many times the machine redials and the time between redials.

Redialing Manually

1. Set documents.
2. Press [Redial/Pause].
3. Press [Start].



NOTE

When <RESTRICT REDIAL> is set to <ON> in the <ACCESS TO DEST.> of the <SYSTEM SETTINGS> menu, redialing is not available.



Back



Previous



Next

TOP

- Before Using the Machine 1
- Document and Paper 2
- Sending and Receiving 3
- Copying 4
- Printing (FAX-L160 Only) 5
- System Manager Settings 6
- Maintenance 7
- Troubleshooting 8
- Appendix 9

Redialing Automatically

The default settings are as follows:

- AUTO REDIAL: <ON>
- REDIAL TIMES: <2TIMES>
- REDIAL INTERVAL: <2MIN.>

1. Press [Menu].
2. Press [◀] or [▶] to select <FAX SETTINGS>, then press [OK].
3. Press [◀] or [▶] to select <TX SETTINGS>, then press [OK].
4. Press [◀] or [▶] to select <AUTO REDIAL>, then press [OK].
5. Press [◀] or [▶] to select <ON>, then press [OK].

6. Press [◀] or [▶] to select the number of redials the machine will make, then press [OK].

Ex.

R E D I A L T I M E S
2 T I M E S

You can also enter values with the numeric keys.

7. Press [◀] or [▶] to select the time (in minutes) between redials, then press [OK].

Ex.

R E D I A L I N T E R V A L
2 M I N .

You can also enter values with the numeric keys.

8. Press [Stop/Reset] to return to the standby mode.



Back



Previous



Next

TOP

Before Using the Machine 1

Document and Paper 2

Sending and Receiving 3

Copying 4

Printing (FAX-L160 Only) 5

System Manager Settings 6

Maintenance 7

Troubleshooting 8

Appendix 9

Table of Contents

Index

■ Checking Dialing Line

Checking dialing line function enables you to configure the setting on whether to check for a dial tone.

1. Press [Menu].
2. Press [◀] or [▶] to select <FAX SETTINGS>, then press [OK].
3. Press [◀] or [▶] to select <TX SETTINGS>, then press [OK].
4. Press [◀] or [▶] to select <DIALING LINE CHCK>, then press [OK].
5. Press [◀] or [▶] to select <ON>, then press [OK].
6. Press [Stop/Reset] to return to the standby mode.

■ Dialing an Overseas Number (With Pauses)

When you dial or register an overseas number, you may need to insert a pause within the number.

NOTE

Make sure the LCD shows the fax mode. If the LCD shows the copy mode, press [Stop/Reset].

1. Set documents.
2. Use the numeric keys to dial the international access code.
For details on international access codes, contact your local telephone company.
3. If necessary, press [Redial/Pause] to insert a pause.

Ex.

= 1 2 3 P _

- The letter <P> is displayed between the numbers.
- <P> in the fax/telephone number represents 2.5-second pause.
- For a longer pause, press [Redial/Pause] again.



Back



Previous



Next

TOP

Before Using the Machine 1

Document and Paper 2

Sending and Receiving 3

Copying 4

Printing (FAX-L160 Only) 5

System Manager Settings 6

Maintenance 7

Troubleshooting 8

Appendix 9

Table of Contents

Index

4. Use the numeric keys to dial the country code, the area code, and the fax/telephone number of the recipient.

5. If necessary, press [Redial/Pause] to enter a pause at the end of the number.

The letter <P> appears at the end of the fax number.

6. Press [Start].



Back



Previous



Next

- Before Using the Machine **1**
- Document and Paper **2**
- Sending and Receiving **3**
- Copying **4**
- Printing (FAX-L160 Only) **5**
- System Manager Settings **6**
- Maintenance **7**
- Troubleshooting **8**
- Appendix **9**

Basic Receiving Method

Follow this procedure to set the machine for receiving faxes. The default setting is <FaxOnly>.

NOTE

Any data stored in the memory, including received fax documents, will be deleted if you disconnect the power cord of the machine.

- 1. Press [Menu].**
- 2. Press [◀-] or [+▶] to select <FAX SETTINGS>, then press [OK].**
- 3. Press [◀-] or [+▶] to select <RX MODE>, then press [OK].**

- 4. Press [◀-] or [+▶] to select the receive mode, then press [OK].**

<FaxOnly>: Answers all calls as faxes.

<AnsMode>: Receives faxes automatically and records voice messages.

<FaxTel>: Switches between fax and voice calls automatically if the optional handset or an external telephone is connected to the machine. For optional settings, see "FAX/TEL: Optional Settings," on p. 3-24.

<MANUAL>: Does not answer any calls. You have to manually receive faxes. See "Manual Reception," on p. 3-25.

NOTE

- For <FaxTel> or <MANUAL>, make sure the optional handset or an external telephone is connected to the machine.
- For <AnsMode>, make sure an answering machine is connected to the machine.

- 5. Press [Stop/Reset] to return to the standby mode.**



Back



Previous



Next

TOP

Before Using the Machine 1

Document and Paper 2

Sending and Receiving 3

Copying 4

Printing (FAX-L160 Only) 5

System Manager Settings 6

Maintenance 7

Troubleshooting 8

Appendix 9

Receiving Features

You can set the fax receive mode to suit your needs, set the machine to receive fax documents into memory (memory lock), and use the external telephone connected to the machine to receive faxes manually (remote reception). You can also set how the received documents are printed.

■ FAX/TEL: Optional Settings

If required, change the optional settings as follows:

1. Press [Menu].
2. Press [◀-] or [+▶] to select <FAX SETTINGS>, then press [OK].
3. Press [◀-] or [+▶] to select <RX SETTINGS>, then press [OK].
4. Press [◀-] or [+▶] to select <FAX/TEL OPT. SET>, then press [OK].

5. For <RING START TIME>, press [◀-], [+▶], or the numeric keys to specify the duration (4 to 30 seconds) for which the machine attempts to detect the fax tone before it starts ringing, then press [OK].

If the machine receives a fax, the machine does not ring and switches to the receive mode automatically.
The default setting is <6SEC>.

6. For <F/T RING TIME>, press [◀-], [+▶], or the numeric keys to specify the duration (10 to 45 seconds) of ringing, then press [OK].

The default setting is <22SEC>.

7. For <F/T SWITCH ACTION>, press [◀-] or [+▶] to select the action the machine will take after the ringing ends, then press [OK].

The default setting is <RECEIVE>.
<RECEIVE>: Receives a fax.
<DISCONNECT>: Disconnects the call.

8. Press [Stop/Reset] to return to the standby mode.

Table of Contents

Index



Back



Previous



Next

TOP

Before Using the Machine 1

Document and Paper 2

Sending and Receiving 3

Copying 4

Printing (FAX-L160 Only) 5

System Manager Settings 6

Maintenance 7

Troubleshooting 8

Appendix 9

Table of Contents

Index

■ Manual Reception

When you select <Manual> in <RX MODE>, follow the procedure below to receive a fax.

1. **When the telephone rings, pick up the optional handset/the external telephone or press [Hook].**
2. **Confirm that the modem's connecting sound is heard, then press [Start].**
3. **Hang up the optional handset or the external telephone.**

■ Memory Reception

The machine automatically receives faxes in memory when printing is disabled under certain conditions (e.g., toner or paper has run out).

Load paper and press [OK] to start printing faxes stored in memory. For toner empty, the machine automatically starts printing when the error is cleared.

NOTE

- The machine memory can store up to 346 fax jobs or approximately 346 pages.*
- * Based on the condition that the other party sends the fax by FAX-L160 with ITU-T Standard Chart No.1, standard mode. The maximum number of pages that the machine's memory can store differs depending on the other party's machine.
- Once the pages are printed, they are deleted from the memory.
- If the memory becomes full, you will not be able to receive the remaining pages. Contact the other party and ask them to resend the remaining pages of the fax.



Back



Previous



Next

TOP

Before Using the Machine 1

Document and Paper 2

Sending and Receiving 3

Copying 4

Printing (FAX-L160 Only) 5

System Manager Settings 6

Maintenance 7

Troubleshooting 8

Appendix 9

Table of Contents

Index

■ Memory Lock Reception

You can set the machine to store all documents in memory without automatically printing them.

The default setting is <OFF>.

1. Press [Menu].
2. Press [◀] or [▶] to select <SYSTEM SETTINGS>, then press [OK].
If the System Password has been set, enter the System Password using the numeric keys, then press [OK].
3. Press [◀] or [▶] to select <COMMUNICATIONS>, then press [OK].
4. Press [◀] or [▶] to select <MEMORY LOCK>, then press [OK].
If the memory lock password has already been set, enter the password, then press [OK].
5. Press [◀] or [▶] to select <ON>, then press [OK].



NOTE

When you select <OFF>, the machine starts to print the received documents in memory.

6. If you want to set a password, press [◀] or [▶] to select <PASSWORD>, then press [OK].

If you do not need to set a password, skip to step 8.

7. Use the numeric keys to enter the memory lock reception password (up to seven digits), then press [OK].

Ex.

```
P A S S W O R D = 5 6 7 8 _
```

If the memory lock password has already been set, press [▶] repeatedly to go to the digit you want to change, and then press [Clear]. Enter a new number with the numeric keys, then press [OK].

8. If you want to specify <MEMORY RX TIME>, press [◀] or [▶] to select <MEMORY RX TIME>, then press [OK].

If you do not need to set the timer for memory lock, skip to step 12.

9. Press [◀] or [▶] to select <ON>, then press [OK].

10. For <MEM. RX START TIME>, use the numeric keys to enter the start time (in 24-hour format), then press [OK].

Ex.

```
MEM . RX START TIME
          0 0 : 0 0
```



Back



Previous



Next

TOP

Before Using the Machine 1

Document and Paper 2

Sending and Receiving 3

Copying 4

Printing (FAX-L160 Only) 5

System Manager Settings 6

Maintenance 7

Troubleshooting 8

Appendix 9

Table of Contents

Index

11. For <MEM. RX END TIME>, use the numeric keys to enter the end time (in 24-hour format), then press [OK].

12. Press [Stop/Reset] to return to the standby mode.

Printing All Documents Stored in Memory

1. Perform step 1 to 3 in “Memory Lock Reception,” on p. 3-26.

2. Press [◀] or [▶] to select <MEMORY LOCK>, then press [OK].

3. Use the numeric keys to enter the memory lock reception password, then press [OK].

4. Press [◀] or [▶] to select <OFF>, then press [OK].

The received documents are printed.

5. Press [Stop/Reset] to return to the standby mode.

■ Remote Reception

Remote reception enables you to use an external telephone connected to the machine to receive faxes manually. This can be useful when the machine is not nearby or is being used by someone else.

The default settings are as follows:

- REMOTE RX: <ON>
- REMOTE RX ID: <25>

Registering Remote Reception ID

Follow this procedure if you want to change the default remote reception ID of 25.

1. Press [Menu].

2. Press [◀] or [▶] to select <FAX SETTINGS>, then press [OK].

3. Press [◀] or [▶] to select <RX SETTINGS>, then press [OK].

4. Press [◀] or [▶] to select <REMOTE RX>, then press [OK].

5. Press [◀] or [▶] to select <ON>, then press [OK].



Back



Previous



Next

TOP

Before Using the Machine 1

Document and Paper 2

Sending and Receiving 3

Copying 4

Printing (FAX-L160 Only) 5

System Manager Settings 6

Maintenance 7

Troubleshooting 8

Appendix 9

Table of Contents

Index

6. Use the numeric keys to enter a new remote reception ID (a combination of two characters using 0 to 9), then press [OK].
7. Press [Stop/Reset] to return to the standby mode.

Receiving a Fax Remotely

1. When you receive a call, pick up the external telephone.
2. Use the numeric keys to enter the two-digit remote reception ID to start reception.



NOTE

If the machine is set for pulse dialing, press [Tone] to switch to tone dialing before pressing the remote reception ID.

3. When the reception is complete, hang up the telephone.

Selecting the Receive Mode for Printing

You can select whether the machine stores all received pages in the memory before printing them out or prints each page as it is received.

1. Press [Menu].
2. Press [◀] or [▶] to select <FAX SETTINGS>, then press [OK].
3. Press [◀] or [▶] to select <RX SETTINGS>, then press [OK].
4. Press [◀] or [▶] to select <RX PRINT>, then press [OK].
5. Press [◀] or [▶] to select desired printing method, then press [OK].
 <MEMORY RX>: Prints after all the pages of the document are received.
 <PRINT RX>: Prints each page as it is received.
6. Press [Stop/Reset] to return to the standby mode.



Back



Previous



Next

TOP

Before Using the Machine 1

Document and Paper 2

Sending and Receiving 3

Copying 4

Printing (FAX-L160 Only) 5

System Manager Settings 6

Maintenance 7

Troubleshooting 8

Appendix 9

Table of Contents

Index

■ Reception Restriction

You can reject incoming faxes from the senders who do not transmit their fax numbers to your machine.

The default setting is <OFF>.

1. Press [Menu].
2. Press [◀-] or [+▶] to select <FAX SETTINGS>, then press [OK].
3. Press [◀-] or [+▶] to select <RX SETTINGS>, then press [OK].
4. Press [◀-] or [+▶] to select <RX RESTRICTION>, then press [OK].
5. Press [◀-] or [+▶] to select <ON>, then press [OK].
6. Press [Stop/Reset] to return to the standby mode.

■ Printing Received Documents

The machine provides the received image reduction.

Received Image Reduction

You can print received documents in a reduced size.

1. Press [Menu].
2. Press [◀-] or [+▶] to select <FAX SETTINGS>, then press [OK].
3. Press [◀-] or [+▶] to select <PRINTER SETTINGS>, then press [OK].
4. Press [◀-] or [+▶] to select <RX REDUCTION>, then press [OK].
5. Press [◀-] or [+▶] to select desired setting, then press [OK].
 <ON>: Reduces the documents automatically depending on the length of the documents.
 <OFF>: Prints documents on a paper without reducing the size.
 <CUT>: Cuts off the end of a document that does not fit on one page up to 24 mm. When the height of the area to be cut off is more than 24 mm, the document will be printed on the following page without being cut off.
6. Press [Stop/Reset] to return to the standby mode.



Back



Previous



Next

TOP

Before Using the Machine 1

Document and Paper 2

Sending and Receiving 3

Copying 4

Printing (FAX-L160 Only) 5

System Manager Settings 6

Maintenance 7

Troubleshooting 8

Appendix 9

Advanced Features

The machine provides the following additional fax modes: **broadcasting, delayed sending, polling, and relay.**

■ Broadcasting

Broadcasting enables you to send the same document to multiple recipients.



NOTE

- A maximum of 131 destinations can be specified at the same time. (Out of the 131 destinations, a maximum of 16 destinations can be specified with the numeric keys.) If you specify a group, which is made up of several destinations, each destination in the group is counted as a separate dialing.
- If you frequently send documents to multiple destinations, it is recommended that you store those destinations as a group.

- 1. Set documents.**
- 2. Press [Add. Mode].**
- 3. Press [←] or [→] to select <BROADCAST>, then press [OK].**

4. Specify the destination.

Use the numeric keys, one touch speed dialing keys, coded speed dialing codes or [Address Book] key to specify recipients. Be sure to press [OK] after entering the recipient's number if you use the numeric keys. You can enter up to 16 different fax numbers using the numeric keys.

5. Repeat step 4 to enter all required destinations.

To check all the specified destinations, press [←] or [→] to scroll the display.

6. Press [Start].

■ Delayed Sending

Delayed sending enables you to start transmission at a specified time. You can combine other fax features with delayed sending.

- 1. Set documents.**
- 2. Press [Add.Mode].**

Table of Contents

Index



Back



Previous



Next

TOP

Before Using the Machine 1

Document and Paper 2

Sending and Receiving 3

Copying 4

Printing (FAX-L160 Only) 5

System Manager Settings 6

Maintenance 7

Troubleshooting 8

Appendix 9

Table of Contents

Index

3. Press [**←**] or [**→**] to select **<DELAYED TX>**, then press [**OK**].
4. Use the numeric keys to enter the time of transmission (in 24-hour format), then press [**OK**].

Ex.

T X	T I M E	S E T . = 2 0 : 0 0
-----	---------	---------------------

5. Use the numeric keys, one-touch speed dialing keys, coded speed dialing codes, or [**Address Book**] key to enter a destination, then press [**OK**].

You can use the following features to send a fax by pressing [Add. Mode].

<BROADCAST>: Sends the same document to multiple recipients at a time. (See "Broadcasting," on p. 3-30.)

<POLLING RX>: Retrieve documents stored in remote machines for polling. (See "Polling Receiving," on p. 3-32.)

<RELAY>: Sends a document to be relayed to other recipients. (See "Relay," on p. 3-33.)

6. Press [**Start**] to scan the document for the delayed sending.

■ Polling

Polling Sending

Polling sending enables you to send a document in response to the recipient machine's request.

You can store up to 30 documents in the memory.

1. Set documents.
2. Press [**Add.Mode**].
3. Press [**←**] or [**→**] to select **<POLLING TX>**, then press [**OK**].
4. Press [**←**] or [**→**] to select **<SINGLE>** or **<MULTI>**, then press [**OK**].
 - <SINGLE>**: The document will be deleted after it is sent to a recipient.
 - <MULTI>**: The document will be retained in memory until manually deleted.



Back



Previous



Next

TOP

Before Using the Machine 1

Document and Paper 2

Sending and Receiving 3

Copying 4

Printing (FAX-L160 Only) 5

System Manager Settings 6

Maintenance 7

Troubleshooting 8

Appendix 9

Table of Contents

Index

5. Use the numeric keys to enter the four-digit subaddress, then press [OK].

If no subaddress is required, press [Start].

Ex.

SUBADDRESS = 1 2 3 4 _

6. Use the numeric keys to enter the four-digit password, then press [OK].

If no password is required, press [Start].

Ex.

PASSWORD = 5 6 7 8 _

7. Press [Start].

Polling Receiving

Polling receiving enables you to retrieve documents stored in remote machines for polling.

- 1. Press [Add.Mode].**
- 2. Press [◀-] or [+▶] to select <POLLING RX>, then press [OK].**
- 3. Use the numeric keys, one-touch speed dialing keys, coded speed dialing codes, or [Address Book] key to enter a destination, then press [OK].**
- 4. Repeat the previous step to enter all required recipients (up to 131), then press [Start].**

If the recipient sets a subaddress and/or password, you also need to set the same subaddress and/or password in the one-touch speed dialing or coded speed dialing codes. See "Storing/Editing One-Touch Speed Dialing Keys/Coded Speed Dialing Codes," p. 3-7.

You can enter only up to 16 destinations if using the numeric keys.



Back



Previous



Next

TOP

Before Using the Machine 1

Document and Paper 2

Sending and Receiving 3

Copying 4

Printing (FAX-L160 Only) 5

System Manager Settings 6

Maintenance 7

Troubleshooting 8

Appendix 9

Table of Contents

Index

■ Relay

Relay enables you to send a document to a remote machine (relay station), which in turn sends the document to other destinations. (The remote machine needs to have the relay feature.) How the document is handled after it reaches the relay station depends on what function is registered in the station's subaddress.

1. Set documents.
2. Press [Add.Mode].
3. Press [←] or [→] to select <RELAY>, then press [OK].
4. Use the numeric keys, one-touch speed dialing key, coded speed dialing, or [Address Book] key to specify the relay station, then press [OK].
5. Use the numeric keys to enter the relay station's subaddress (up to 20 digits), then press [OK].

Ex.

SUBADDRESS = 1 2 3 4 _

6. Use the numeric keys to enter the password (up to 20 digits).

If no password is required, press [Start].

Ex.

PASSWORD = 5 6 7 8 _

7. Press [Start].



Back



Previous



Next

TOP

Before Using the Machine 1

Document and Paper 2

Sending and Receiving 3

Copying 4

Printing (FAX-L160 Only) 5

System Manager Settings 6

Maintenance 7

Troubleshooting 8

Appendix 9

Table of Contents

Index

Canceling TX/RX Jobs

Follow the procedure below to cancel an ongoing job (sending or receiving).

1. Press [Stop/Reset].
2. When the <CANCEL DURING TX/RX?> message appears, press [←] to select <YES>.

```
CANCEL DURING TX/RX?  
< YES                NO >
```



Back



Previous



Next

TOP

Before Using the Machine 1

Document and Paper 2

Sending and Receiving 3

Copying 4

Printing (FAX-L160 Only) 5

System Manager Settings 6

Maintenance 7

Troubleshooting 8

Appendix 9

Table of Contents

Index

Checking and Deleting TX/RX Jobs

System monitor enables you to view the transmission and reception results, monitor the status of the send and receive jobs currently being processed.

■ Checking Transmission/Reception Results

1. Press [System Monitor].
2. Press [◀] or [▶] to select <TX/RX LOG>, then press [OK].
3. Press [◀] or [▶] to view the required transmission/reception result.
4. Press [Stop/Reset] to return to the standby mode.

■ Checking and Deleting Fax Documents Stored in Memory

1. Press [System Monitor].
2. Press [◀] or [▶] to select <TX STATUS>, then press [OK].
3. Press [◀] or [▶] to scroll through the job list, and check the status of the fax jobs.
If you want to delete the job, go to step 4. Otherwise, press [Stop/Reset] to return to the standby mode.
4. Press [◀] or [▶] to select the desired job, then press [OK].



NOTE

For <BROADCAST>, all recipients entered for a broadcasting job will be canceled.

5. Press [◀] to select <YES>.
If you do not want to cancel the job, press [▶] to select <NO>.
6. Press [Stop/Reset] to return to the standby mode.



Back



Previous



Next

TOP

Before Using the Machine 1

Document and Paper 2

Sending and Receiving 3

Copying 4

Printing (FAX-L160 Only) 5

System Manager Settings 6

Maintenance 7

Troubleshooting 8

Appendix 9

Table of Contents

Index

4 Copying

Basic Copying Method	4-2
Scan Settings	4-3
Image Quality	4-3
Density	4-3
Zoom Ratio	4-4
Canceling Copy Jobs	4-5



Back



Previous



Next

TOP

Before Using the Machine 1

Document and Paper 2

Sending and Receiving 3

Copying 4

Printing (FAX-L160 Only) 5

System Manager Settings 6

Maintenance 7

Troubleshooting 8

Appendix 9

Table of Contents

Index

Basic Copying Method

Follow this procedure to make a copy.

- 1. Set documents.**
For documents you can copy, see "Document Requirements," on p. 2-2.
- 2. Press [Copy].**
The copy mode automatically resets to the fax mode after one minute of inactivity, or when you press [Stop/Reset].
- 3. Use the numeric keys to enter the desired copy quantity (1 to 99).**
- 4. Press [Start].**



Back



Previous



Next

TOP

- Before Using the Machine 1
- Document and Paper 2
- Sending and Receiving 3
- Copying 4
- Printing (FAX-L160 Only) 5
- System Manager Settings 6
- Maintenance 7
- Troubleshooting 8
- Appendix 9

Scan Settings

Before pressing [Start] to begin copying, you can adjust the settings to better suit the document to be scanned. These settings return to the default values if the machine remains idle for one minute or if you press [Stop/Reset].

■ Image Quality

The default setting is <TEXT>.

1. Press [Copy].
2. Press [Image Quality] repeatedly to select the document type.

<TEXT>: for text documents

<PHOTO>: for documents that contain fine text or photos

<TEXT/PHOTO>: for documents that contain text and photos

NOTE

- When you press [Stop/Reset], the setting will be canceled. If you want to keep the settings, set the image quality as following:
[Menu] → <COPY SETTINGS> → <STANDARD SETTINGS> → <IMAGE QUALITY> → Press [◀] or [▶] to select the desired document type.
- Copy density automatically changes to the manual mode when <TEXT/PHOTO> or <PHOTO> is set.

■ Density

You can adjust the density to the most appropriate level for the document either automatically or manually. The default setting is <MANUAL> (5).

Adjusting Automatically

1. Press [Copy].
2. Press [Density] repeatedly to select <AUTO>, then press [OK].

NOTE

The image quality is automatically set to <TEXT>.

- Table of Contents
- Index



Back



Previous



Next

- Before Using the Machine 1
- Document and Paper 2
- Sending and Receiving 3
- Copying 4
- Printing (FAX-L160 Only) 5
- System Manager Settings 6
- Maintenance 7
- Troubleshooting 8
- Appendix 9

Adjusting Manually

1. Press [Copy].
2. Press [Density] repeatedly to select the manual mode.
3. Press [◀-] or [+▶] to adjust the copy density, then press [OK].

Ex.



[◀-]: to make dark documents lighter
 [+▶]: to make light documents darker

NOTE

When you press [Stop/Reset], the setting will be canceled. If you want to keep the settings, set the density as following:
 [Menu] → <COPY SETTINGS> → <STANDARD SETTINGS> → <DENSITY> → <MANUAL>
 (See "Setting Menu," on p. 9-5.)

Zoom Ratio

You can reduce or enlarge images by any copy ratio, in 1% increments. The available copy ratios are from 50% to 200%. The default setting is <100%>.

1. Press [Copy].
2. Press [◀-] or [+▶] to adjust the zoom ratio, then press [OK].

[◀-]: to decrease the zoom ratio
 [+▶]: to increase the zoom ratio

NOTE

When you press [Stop/Reset], the setting will be canceled. If you want to keep the settings, set the zoom ratio as following:
 [Menu] → <COPY SETTINGS> → <STANDARD SETTINGS> → <ZOOM RATIO> → Press [◀-] or [+▶] to change the zoom ratio.



Back



Previous



Next

TOP

Before Using the Machine 1

Document and Paper 2

Sending and Receiving 3

Copying 4

Printing (FAX-L160 Only) 5

System Manager Settings 6

Maintenance 7

Troubleshooting 8

Appendix 9

Table of Contents

Index

Canceling Copy Jobs

Follow this procedure to cancel an outgoing job.

1. Press [Stop/Reset].
2. When the <CANCEL COPYING?> message appears, press [←] to select <YES>.

```
CANCEL  COPYING?  
< YES                NO >
```

The job is canceled, and the copy quantity is reset.



Back



Previous



Next

TOP

Before Using the Machine 1

Document and Paper 2

Sending and Receiving 3

Copying 4

Printing (FAX-L160 Only) 5

System Manager Settings 6

Maintenance 7

Troubleshooting 8

Appendix 9

Table of Contents

Index

5 Printing (FAX-L160 Only)

Printing Documents	5-2
Advanced Printing Features	5-3
Collate Printing	5-3
Checking and Deleting Jobs	5-4
Checking and Deleting Print Jobs.....	5-4



Back



Previous



Next

TOP

Before Using the Machine 1

Document and Paper 2

Sending and Receiving 3

Copying 4

Printing (FAX-L160 Only) 5

System Manager Settings 6

Maintenance 7

Troubleshooting 8

Appendix 9

Printing Documents

Follow this procedure to print a document from your computer. Make sure that the printer driver is installed. To check if the driver is installed, see “Software Settings with Computer” in the Starter Guide.

For details on the printer driver settings, see [Online Help](#).



NOTE

How to display the print screen or items on the screen may vary depending on your application and/or OS.

1. From an open document on an application, click [File] → [Print].
2. Select the printer icon for the machine ([Canon L90/L160/L230 UFR II LT]), then click [Preferences] or [Properties] to open the dialog box.
3. After finished setting, click [OK].
4. Click [Print] or [OK].

Table of Contents

Index



Back



Previous



Next

TOP

Before Using the Machine 1

Document and Paper 2

Sending and Receiving 3

Copying 4

Printing (FAX-L160 Only) 5

System Manager Settings 6

Maintenance 7

Troubleshooting 8

Appendix 9

Advanced Printing Features

■ Collate Printing

You can print documents collated into sets arranged in page order. For example, when printing multiple copies of a 3-page document, the print order is 1, 2, 3, 1, 2, 3, and so on.

1. From an open document on an application, click [File] → [Print].
2. Select the printer icon for the machine ([Canon L90/L160/L230 UFR II LT]), then click [Preferences] or [Properties] to open the dialog box.
3. Click the [Finishing] tab.
4. For [Finishing], select [Collate], then click [OK].
5. On the [Print] dialog box, click [Print] or [OK].

Table of Contents

Index



Back



Previous



Next

TOP

Before Using the Machine 1

Document and Paper 2

Sending and Receiving 3

Copying 4

Printing (FAX-L160 Only) 5

System Manager Settings 6

Maintenance 7

Troubleshooting 8

Appendix 9

Table of Contents

Index

Checking and Deleting Jobs

System monitor enables you to monitor the status of the print jobs currently being processed.



NOTE

Make sure that the Processing/Data indicator is turned on. When the Processing/Data indicator is turned off, all print jobs are erased from the memory.

■ Checking and Deleting Print Jobs

1. Press [System Monitor].
2. Press [◀-] or [+▶] to select <PRINT STATUS>, then press [OK].
3. Press [◀-] or [+▶] to scroll through the job list, and check the status of the print jobs.
If you want to delete the job, go to step 4. Otherwise, press [Stop/Reset] to return to the standby mode.
4. Press [◀-] or [+▶] to select the desired job, then press [OK].

5. Press [◀-] to select <YES>.

If you do not want to cancel the job, press [+▶] to select <NO>.

6. Press [Stop/Reset] to return to the standby mode.



Back



Previous



Next

TOP

6 System Manager Settings

Before Using the Machine 1

Document and Paper 2

Sending and Receiving 3

Copying 4

Printing (FAX-L160 Only) 5

System Manager Settings 6

Maintenance 7

Troubleshooting 8

Appendix 9

Table of Contents

Index

Specifying the System Manager Settings6-2

Restricting Access to Destinations6-3

Confirming Entered Fax Numbers6-3

Restricting Redial6-3



Back



Previous



Next

TOP

Before Using the Machine 1

Document and Paper 2

Sending and Receiving 3

Copying 4

Printing (FAX-L160 Only) 5

System Manager Settings 6

Maintenance 7

Troubleshooting 8

Appendix 9

Specifying the System Manager Settings

You can set a password for the System Manager. Once the System Password is set, restrictions can be placed on storing or changing the System Settings.

1. Press [Menu].
2. Press [◀-] or [+▶] to select <SYSTEM SETTINGS>, then press [OK].
If the System Password has been set, enter the System Password using the numeric keys, then press [OK].
3. Press [◀-] or [+▶] to select <SYS. MANAGER INFO>, then press [OK].
4. Press [◀-] or [+▶] to select <SYSTEM PASSWORD>, then press [OK].
5. Use the numeric keys to enter a number (up to seven digits), then press [OK].



NOTE

If you make a mistake when entering a number, press [Clear] to clear the entire number, and then enter the correct number.

6. Press [Stop/Reset] to return to the standby mode.

Table of Contents

Index



Back



Previous



Next

TOP

Before Using the Machine 1

Document and Paper 2

Sending and Receiving 3

Copying 4

Printing (FAX-L160 Only) 5

System Manager Settings 6

Maintenance 7

Troubleshooting 8

Appendix 9

Restricting Access to Destinations

You can send the documents with following restrictions or settings.

- Confirming Entered Fax Numbers
- Restricting Redial

■ Confirming Entered Fax Numbers

You can specify whether or not to confirm the entered fax numbers each time you send a fax.

The default setting is <OFF>.

1. Press [Menu].
2. Press [◀-] or [+▶] to select <SYSTEM SETTINGS>, then press [OK].
If the System Password has been set, enter the System Password using the numeric keys, then press [OK].
3. Press [◀-] or [+▶] to select <ACCESS TO DEST.>, then press [OK].

4. Press [◀-] or [+▶] to select <CONFIRM FAX NO.>, then press [OK].

5. Press [◀-] or [+▶] to select <ON> or <OFF>, then press [OK].

<OFF>: The confirmation screen does not appear.

<ON>: The confirmation screen appears when you enter a fax number using the numeric keys.

6. Press [Stop/Reset] to return to the standby mode.

■ Restricting Redial

You can specify whether or not to allow using [Redial/Pause].

The default setting is <OFF>.

1. Press [Menu].
2. Press [◀-] or [+▶] to select <SYSTEM SETTINGS>, then press [OK].
If the System Password has been set, enter the System Password using the numeric keys, then press [OK].

Table of Contents

Index



Back



Previous



Next

TOP

Before Using the Machine 1

Document and Paper 2

Sending and Receiving 3

Copying 4

Printing (FAX-L160 Only) 5

System Manager Settings 6

Maintenance 7

Troubleshooting 8

Appendix 9

Table of Contents

Index

3. Press [**←**] or [**→**] to select **<ACCESS TO DEST.>**, then press [OK].
4. Press [**←**] or [**→**] to select **<RESTRICT REDIAL>**, then press [OK].
5. Press [**←**] or [**→**] to select **<ON>** or **<OFF>**, then press [OK].
6. Press [Stop/Reset] to return to the standby mode.



Back



Previous



Next

TOP

Before Using the Machine 1

Document and Paper 2

Sending and Receiving 3

Copying 4

Printing (FAX-L160 Only) 5

System Manager Settings 6

Maintenance 7

Troubleshooting 8

Appendix 9

Table of Contents

Index

7 Maintenance

Cleaning the Machine	7-2
Exterior.....	7-2
Interior	7-2
Fuser Roller.....	7-6
Scanning area.....	7-6
Replacing the Toner Cartridge	7-8
Redistributing Toner	7-8
Replacing the Toner Cartridge with a New One	7-12
Transporting the Machine	7-17



Back



Previous



Next

TOP

Before Using the Machine 1

Document and Paper 2

Sending and Receiving 3

Copying 4

Printing (FAX-L160 Only) 5

System Manager Settings 6

Maintenance 7

Troubleshooting 8

Appendix 9

Table of Contents

Index

Cleaning the Machine

Note the following before cleaning your machine:

- Make sure no document is stored in memory, and disconnect the power cord.
- Use a soft cloth to avoid scratching the components.
- Do not use tissue paper, paper towels, or similar materials for cleaning; they can stick to the components or generate static charges.

CAUTION

Never use volatile liquids such as thinners, benzene, acetone, or any other chemical cleaner to clean the machine. These can damage the machine components.

NOTE

When you disconnect the power cord, the documents stored in memory will be erased. To check the jobs stored in memory, see the following:

- Checking and Deleting Fax Documents Stored in Memory on p. 3-35
- Checking and Deleting Print Jobs on p. 5-4

■ Exterior

1. **Disconnect the power cord from the machine.**
2. **Wipe the machine's exterior with a clean, soft, lint-free cloth dampened with water or diluted dishwashing detergent solution.**
3. **Wait for the machine to dry, then reconnect the power cord.**

■ Interior

Clean the machine's print area periodically to prevent toner powder and paper dust from accumulating inside.

1. **Disconnect the power cord from the machine.**



Back



Previous



Next

TOP

Before Using the Machine 1

Document and Paper 2

Sending and Receiving 3

Copying 4

Printing (FAX-L160 Only) 5

System Manager Settings 6

Maintenance 7

Troubleshooting 8

Appendix 9

Table of Contents

Index

2. Close the paper delivery tray extension (A), and then the paper delivery tray (B) itself.

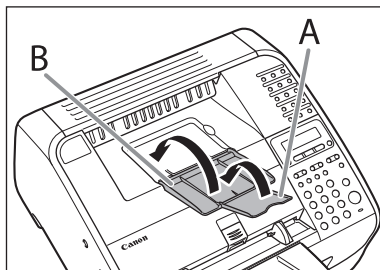

CAUTION

Do not close the paper delivery tray without folding the extension first.

3. Open the toner cover by the notch (A).

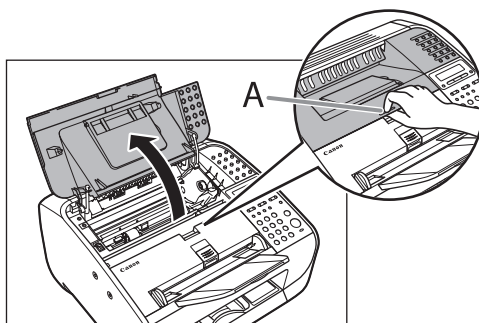

4. Remove the toner cartridge.

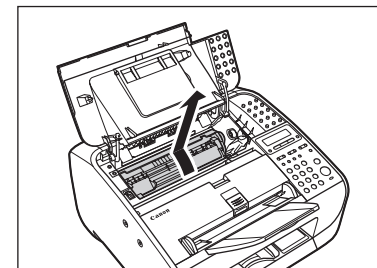

CAUTION

- Do not touch the rollers and parts which have labels "CAUTION! Hot surface avoid contact" on. They become very hot during use.
- To avoid exposing the toner cartridge to light, place it in its protective bag or wrap it in a thick cloth.
- Do not open the drum protective shutter on the toner cartridge. Print quality may deteriorate if the drum surface is exposed to light or is damaged.

NOTE

Always hold the toner cartridge by its handle.



Back



Previous



Next

TOP

Before Using the Machine 1

Document and Paper 2

Sending and Receiving 3

Copying 4

Printing (FAX-L160 Only) 5

System Manager Settings 6

Maintenance 7

Troubleshooting 8

Appendix 9

Table of Contents

Index

5. Use a clean, soft, dry, lint-free cloth to remove any toner or paper debris from the machine's interior.

CAUTION

- Do not touch the fixing assembly (A) as it becomes very hot during use.
- Do not touch the pins (B) or the transfer roller (C) as this can damage the machine.

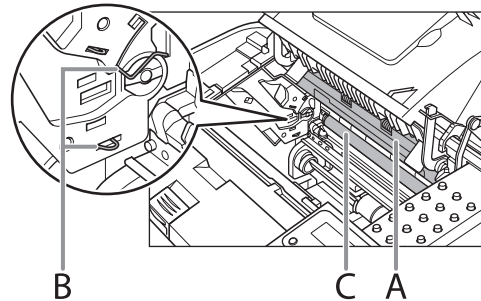

- If loose toner comes into contact with your skin or clothing, wash with cold water. Warm water will set the toner.

6. Hold the toner cartridge by its handle (A).

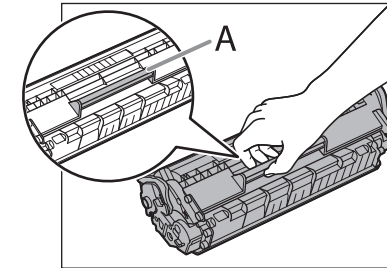

7. The arrow (A) on the toner cartridge should be facing away from you and pointing down.

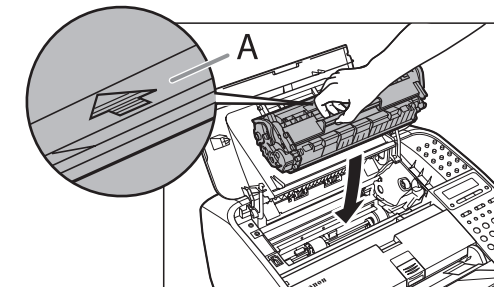



Back



Previous



Next

TOP

Before Using the Machine 1

Document and Paper 2

Sending and Receiving 3

Copying 4

Printing (FAX-L160 Only) 5

System Manager Settings 6

Maintenance 7

Troubleshooting 8

Appendix 9

Table of Contents

Index

- 8. Insert the toner cartridge so that the guide (A) on the left side of the toner cartridge fits into the groove inside the machine and slide it down parallel to the guide.

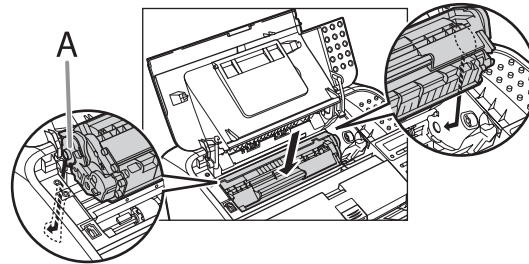

- 9. Push the toner cartridge to make sure it is properly set in the machine.

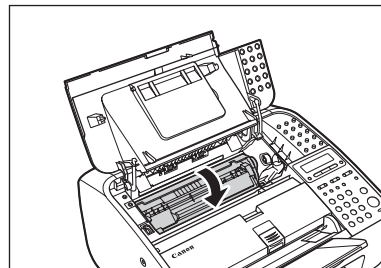

- 10. Close the toner cover.

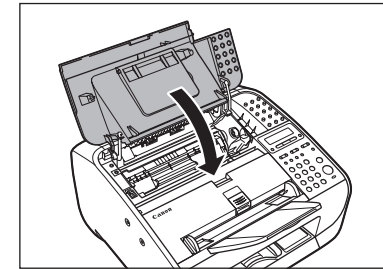

CAUTION

Be careful not to get your fingers caught.

- 11. Reconnect the power cord.



Back



Previous



Next

TOP

- Before Using the Machine 1
- Document and Paper 2
- Sending and Receiving 3
- Copying 4
- Printing (FAX-L160 Only) 5
- System Manager Settings 6
- Maintenance 7
- Troubleshooting 8
- Appendix 9

- Table of Contents
- Index

■ Fuser Roller

If black streaks appear with printing, the fuser roller in the main unit may be dirty. Should this occur, clean the fusing roller in the following procedure. The roller should also be cleaned each time the toner cartridge is replaced. Load a sheet of blank A4 paper into the paper feeder and start cleaning.



NOTE

Cleaning the roller takes approximately 180 seconds.

1. Press [Menu].
2. Press [←] or [→] to select <ADJUST./CLEANING>, then press [OK].
3. Make sure that a sheet of blank A4 paper is in the paper feeder.
4. Press [←] or [→] to select <FIX.UNIT CLEANING>, then press [OK].



NOTE

Use standard paper as the cleaning paper. Throw away the cleaning paper after use.

■ Scanning area

Keep the scanning area clean to avoid dirty copies or faxes to be sent.

If your documents have black streaks or appear dirty after copying them using the ADF, this may be caused by pencil lead rubbing off the documents and onto the roller. Clean the ADF scanning area and roller.

1. Disconnect the power cord from the machine.
2. Lift the paper stack cover and pull it out completely.

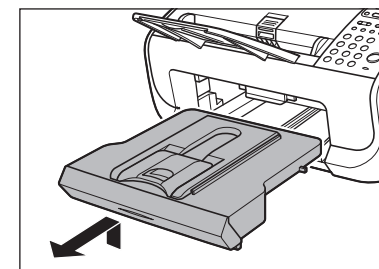

NOTE

Make sure the back end of the cover does not catch the front paper guide.



Back



Previous



Next

TOP

- Before Using the Machine **1**
- Document and Paper **2**
- Sending and Receiving **3**
- Copying **4**
- Printing (FAX-L160 Only) **5**
- System Manager Settings **6**
- Maintenance **7**
- Troubleshooting **8**
- Appendix **9**

- 3. Lower the scanning platform (A) in the document delivery slot.**

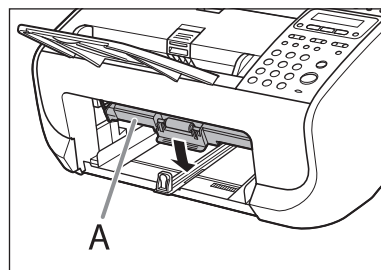

- 4. Gently wipe the scanning glass (A) and white sheet (B) with a clean, soft, lint-free cloth moistened with water.**

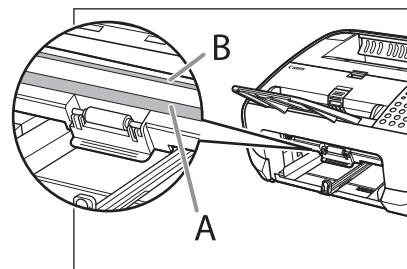

NOTE

Do not dampen the cloth too much, as this may tear the document or damage the machine.

- 5. After the scanning area becomes dry, lift the scanning platform back into place.**

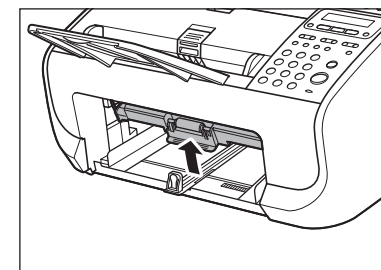

- 6. Insert the paper stack cover.**

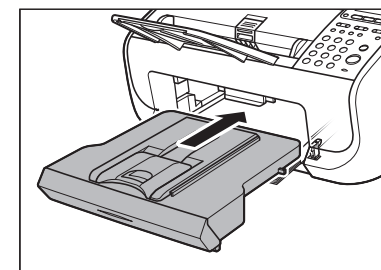

NOTE

Make sure the back end of the cover does not catch and lower the scanning platform.

- 7. Reconnect the power cord.**

- Table of Contents
- Index



Back



Previous



Next

TOP

Before Using the Machine 1

Document and Paper 2

Sending and Receiving 3

Copying 4

Printing (FAX-L160 Only) 5

System Manager Settings 6

Maintenance 7

Troubleshooting 8

Appendix 9

Table of Contents

Index

Replacing the Toner Cartridge

When the toner is running low, the message <TONER LOW/ PREPARE NEW TONER> appears on the LCD. We recommend that you prepare a new toner cartridge for future replacement with ease.

When the message <OUT OF TONER /CHANGE TONER> appears, redistribute toner in the toner cartridge. If the message persists, replace the toner cartridge with a new one.

When toner empty error occurs while receiving fax, printing fax is interrupted and the received data will be stored in the memory. If you set <CONT. PRINTING> in <PRINTER SETTINGS> in <FAX SETTINGS> to <ON>, you can keep printing fax documents or reports without replacing the toner cartridge.

The default setting for <CONT.PRINTING> is <OFF>. (See "Setting Menu," on p. 9-5.)

CAUTION

- When <CONT. PRINTING> is set to <ON>, the printed documents may be light or blurred because of lack of toner. The data is erased when the documents are printed out, so you can not print the same documents again.
- Do not touch the rollers and parts which have labels "CAUTION! Hot surface avoid contact" on. They become very hot during use.

Redistributing Toner

1. Close the paper delivery tray extension (A), and then the paper delivery tray (B) itself.

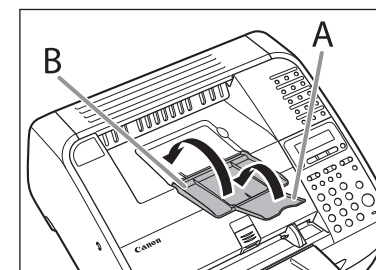

CAUTION

Do not close the paper delivery tray without folding the extension first.



Back



Previous



Next

TOP

Before Using the Machine 1

Document and Paper 2

Sending and Receiving 3

Copying 4

Printing (FAX-L160 Only) 5

System Manager Settings 6

Maintenance 7

Troubleshooting 8

Appendix 9

2. Open the toner cover by the notch (A).

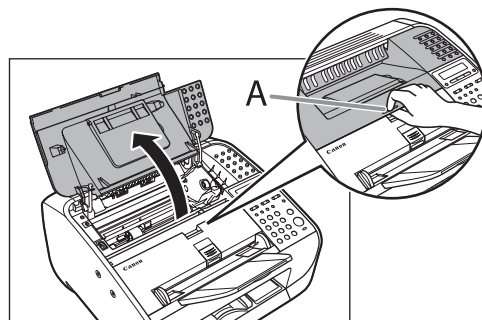

3. Remove the toner cartridge.

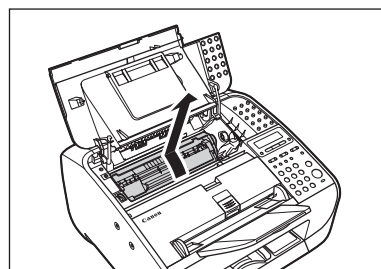

CAUTION

Do not touch the rollers and parts which have labels "CAUTION! Hot surface avoid contact" on. They become very hot during use.

4. Gently rock the toner cartridge several times to evenly distribute the toner inside.

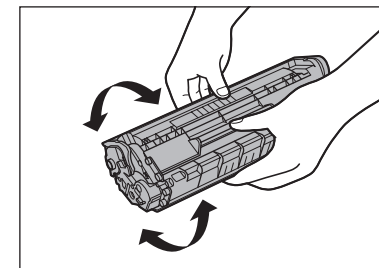

Table of Contents

Index



Back



Previous



Next

TOP

Before Using the Machine 1

Document and Paper 2

Sending and Receiving 3

Copying 4

Printing (FAX-L160 Only) 5

System Manager Settings 6

Maintenance 7

Troubleshooting 8

Appendix 9

Table of Contents

Index

5. Hold the toner cartridge by its handle (A).

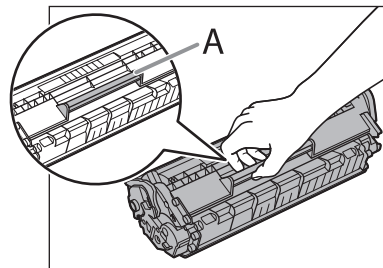

CAUTION

Do not open the drum protective shutter (A).

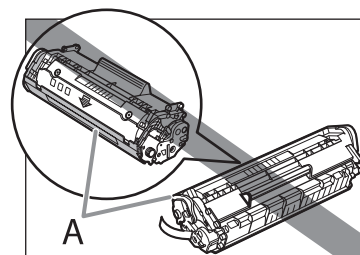

NOTE

Always hold the toner cartridge by its handle.

6. The arrow (A) on the toner cartridge should be facing away from you and pointing down.

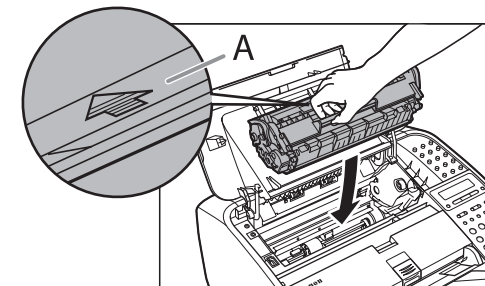

7. Insert the toner cartridge so that the guide (A) on the left side of the toner cartridge fits into the groove inside the machine and slide it down parallel to the guide.

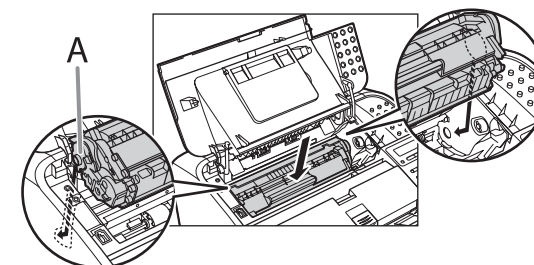



Back



Previous



Next

TOP

Before Using the Machine 1

Document and Paper 2

Sending and Receiving 3

Copying 4

Printing (FAX-L160 Only) 5

System Manager Settings 6

Maintenance 7

Troubleshooting 8

Appendix 9

Table of Contents

Index

- 8. Push the toner cartridge to make sure it is properly set in the machine.

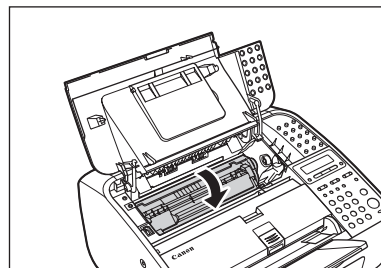

- 9. Close the toner cover.

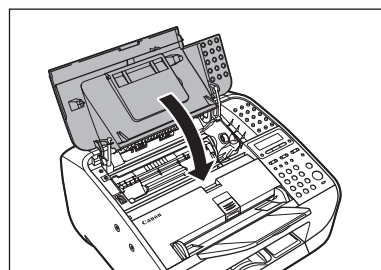

! CAUTION

Be careful not to get your fingers caught.

- 10. Open the paper delivery tray (A) and the extension (B).

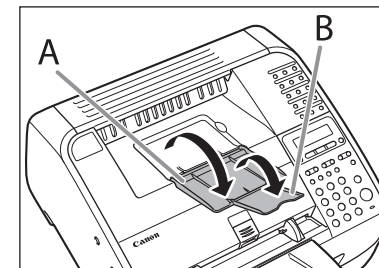



Back



Previous



Next

TOP

Before Using the Machine 1

Document and Paper 2

Sending and Receiving 3

Copying 4

Printing (FAX-L160 Only) 5

System Manager Settings 6

Maintenance 7

Troubleshooting 8

Appendix 9

■ Replacing the Toner Cartridge with a New One

1. Close the paper delivery tray extension (A), and then the paper delivery tray (B) itself.

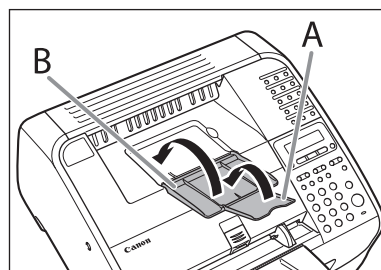

⚠ CAUTION

Do not close the paper delivery tray without folding the extension first.

2. Open the toner cover by the notch (A).

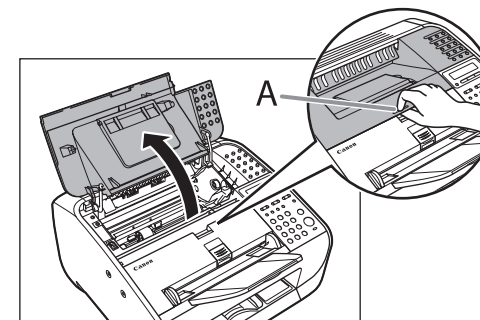

3. Remove the toner cartridge.

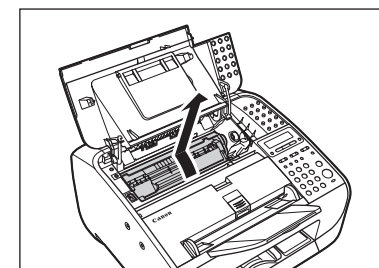

Table of Contents

Index



Back



Previous



Next

TOP

Before Using the Machine 1

Document and Paper 2

Sending and Receiving 3

Copying 4

Printing (FAX-L160 Only) 5

System Manager Settings 6

Maintenance 7

Troubleshooting 8

Appendix 9

Table of Contents

Index

4. Remove the new toner cartridge from the protective bag.

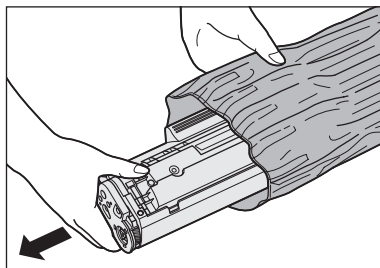

CAUTION

Do not open the drum protective shutter (A).

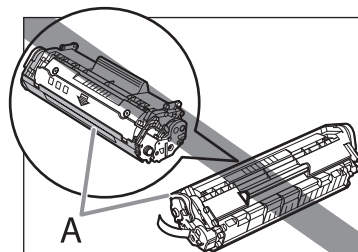

NOTE

Save the protective bag. You may need it later when you remove the toner cartridge from the machine.

5. Gently rock the toner cartridge several times to evenly distribute the toner inside.

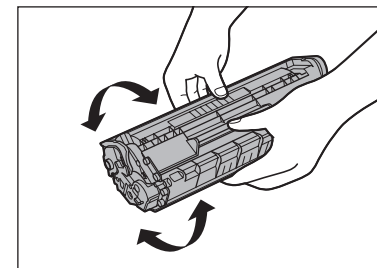



Back



Previous



Next

TOP

- Before Using the Machine **1**
- Document and Paper **2**
- Sending and Receiving **3**
- Copying **4**
- Printing (FAX-L160 Only) **5**
- System Manager Settings **6**
- Maintenance **7**
- Troubleshooting **8**
- Appendix **9**

6. Hold the toner cartridge with one hand, and pull the seal completely out.

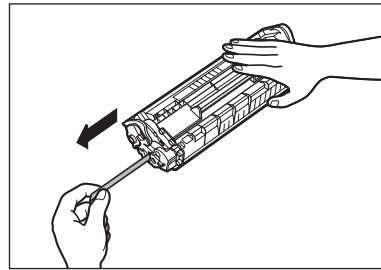

CAUTION

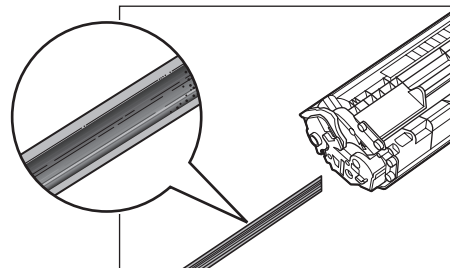

- If toner is adhered on the removed seal, be careful that your hands or clothes do not get dirty from touching the toner.
- If your hands or clothes get dirty from touching the toner, wash them immediately in cold water. Do not use hot water. If you do, the toner may be set permanently.

NOTE

Do not pull the seal out at an angle.

7. Hold the toner cartridge by its handle (A).

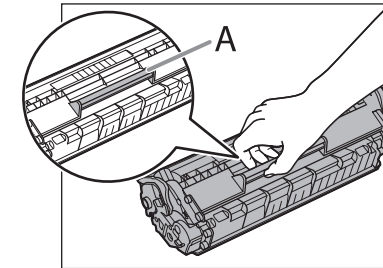

CAUTION

Do not open the drum protective shutter on the toner cartridge. Print quality may deteriorate if the drum surface is exposed to light or is damaged.

NOTE

Always hold the toner cartridge by its handle.



Back



Previous



Next

TOP

Before Using the Machine 1

Document and Paper 2

Sending and Receiving 3

Copying 4

Printing (FAX-L160 Only) 5

System Manager Settings 6

Maintenance 7

Troubleshooting 8

Appendix 9

Table of Contents

Index

- 8. The arrow (A) on the toner cartridge should be facing away from you and pointing down.

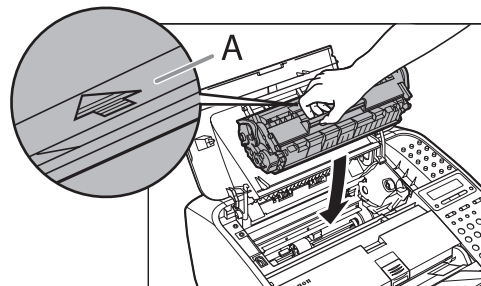

- 9. Insert the toner cartridge so that the guide (A) on the left side of the toner cartridge fits into the groove inside the machine and slide it down parallel to the guide.

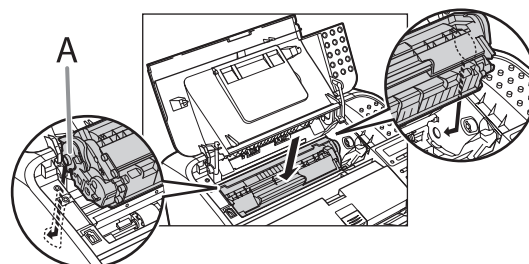

- 10. Push the toner cartridge to make sure it is properly set in the machine.

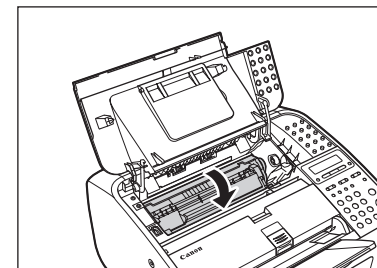

- 11. Close the toner cover.

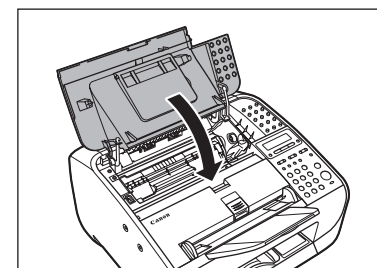

CAUTION

Be careful not to get your fingers caught.



Back



Previous



Next

TOP

Before Using the Machine 1

Document and Paper 2

Sending and Receiving 3

Copying 4

Printing (FAX-L160 Only) 5

System Manager Settings 6

Maintenance 7

Troubleshooting 8

Appendix 9

Table of Contents

Index

12. Open the paper delivery tray (A) and the extension (B).

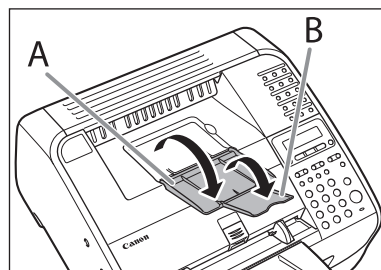



Back



Previous



Next

TOP

Before Using the Machine 1

Document and Paper 2

Sending and Receiving 3

Copying 4

Printing (FAX-L160 Only) 5

System Manager Settings 6

Maintenance 7

Troubleshooting 8

Appendix 9

Transporting the Machine

Follow this procedure to avoid vibration damage to the machine when transporting it over a long distance.

1. Disconnect the power cord and all the cables from the back of the machine.
2. Close the paper delivery tray extension (A), and then the paper delivery tray (B) itself.

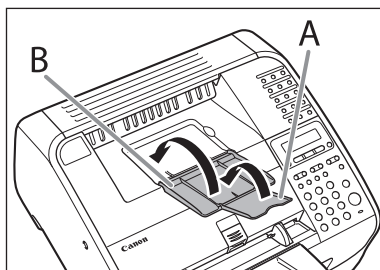

Do not close the paper delivery tray without folding the extension first.

3. Open the toner cover by the notch (A).

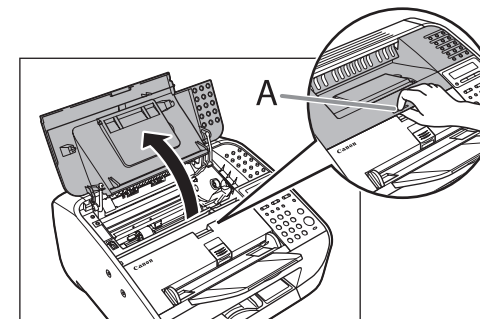

Table of Contents

Index



Back



Previous



Next

TOP

Before Using the Machine 1

Document and Paper 2

Sending and Receiving 3

Copying 4

Printing (FAX-L160 Only) 5

System Manager Settings 6

Maintenance 7

Troubleshooting 8

Appendix 9

Table of Contents

Index

4. Remove the toner cartridge.

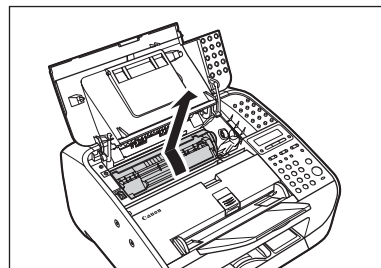

CAUTION

- To avoid exposing the toner cartridge to light, place it in its protective bag or wrap it in a thick cloth.
- Do not open the drum protective shutter (A).

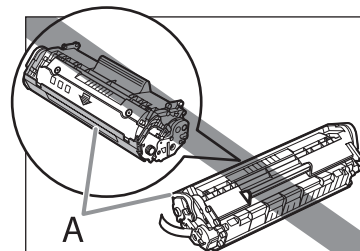

NOTE

Always hold the toner cartridge by its handle.

5. Close the toner cover.

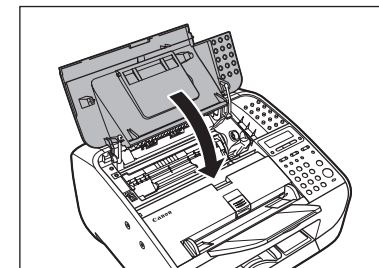

CAUTION

Be careful not to get your fingers caught.

6. Detach the document feeder tray.

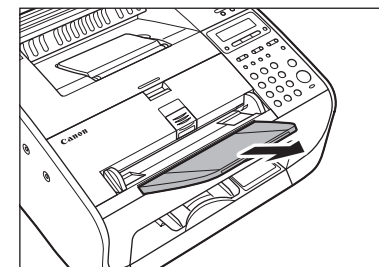



Back



Previous



Next

TOP

Before Using the Machine 1

Document and Paper 2

Sending and Receiving 3

Copying 4

Printing (FAX-L160 Only) 5

System Manager Settings 6

Maintenance 7

Troubleshooting 8

Appendix 9

Table of Contents

Index

7. Fold the document delivery tray extension (A), and then push the document delivery tray (B) into the machine.

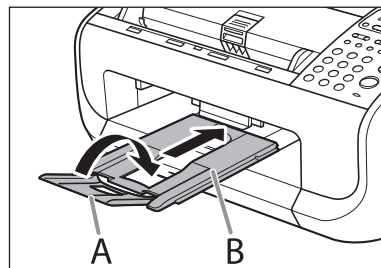

CAUTION

Do not open or close the document delivery tray extension without extending the document delivery tray first.



Back



Previous



Next

TOP

8 Troubleshooting

Before Using the Machine 1

Document and Paper 2

Sending and Receiving 3

Copying 4

Printing (FAX-L160 Only) 5

System Manager Settings 6

Maintenance 7

Troubleshooting 8

Appendix 9

Table of Contents

Index

Clearing Jams.....	8-3
Document Jams.....	8-3
Paper Jams.....	8-5
LCD Messages	8-10
Error Codes	8-16
If <LOAD CORRECT PAPER> is displayed	8-18
Re-Loading the Paper.....	8-18
Changing the Paper Size Setting.....	8-18
General Problems.....	8-19
Paper Feeding Problems.....	8-20



Back



Previous



Next

TOP

- Before Using the Machine 1
- Document and Paper 2
- Sending and Receiving 3
- Copying 4
- Printing (FAX-L160 Only) 5
- System Manager Settings 6
- Maintenance 7
- Troubleshooting 8
- Appendix 9

- Table of Contents
- Index

- Sending/Receiving Problems8-21**
 - Sending Problems..... 8-21
 - Receiving Problems..... 8-24
- Copying Problems8-30**
- Printing Problems (FAX-L160 Only)8-32**
- Telephone Problems8-35**
- If a Power Failure Occurs.....8-36**
- If You Cannot Solve a Problem8-37**



Back



Previous



Next

TOP

Before Using the Machine 1

Document and Paper 2

Sending and Receiving 3

Copying 4

Printing (FAX-L160 Only) 5

System Manager Settings 6

Maintenance 7

Troubleshooting 8

Appendix 9

Clearing Jams

When <CHECK DOCUMENT> or <PAPER JAM/OPEN TONER COVER> appears on the LCD display, remove jammed paper from the machine first, then from the paper feeder if necessary. Check the following if you experience repeated paper jams:

- Fan and tap the paper stack on a flat surface before loading it in the machine.
- Check that the paper you are using meets the requirements for use. (See "Paper Requirements," on p. 2-5.)
- Make sure you have removed any scraps of paper from the inside of the machine.

CAUTION

- When removing jammed documents or paper, take care not to cut your hands on the edges of the document or paper.
- When removing jammed paper or when inspecting the inside of the machine, do not allow necklaces, bracelets, or other metal objects to touch the inside of the machine, as this may result in burns or electrical shock.
- If you tear the paper, remove any torn pieces to avoid further jams.
- If loose toner comes into contact with your skin or clothing, wash with cold water. Warm water will set the toner.

NOTE

Do not force a jammed document or paper out of the machine. Contact your local authorized Canon dealer or the Canon help line for assistance if needed.

Document Jams

When <CHECK DOCUMENT> appears on the LCD display, remove a jammed document from the ADF.

1. Lift the document release lever.

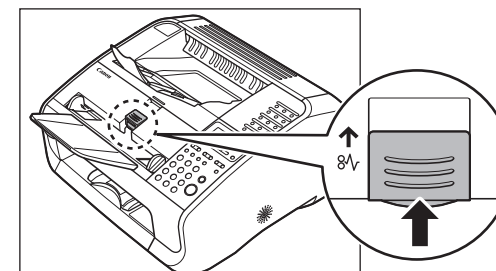

If a multi-page document is loaded, remove the entire document from the ADF.

Table of Contents

Index



Back



Previous



Next

TOP

Before Using the Machine 1

Document and Paper 2

Sending and Receiving 3

Copying 4

Printing (FAX-L160 Only) 5

System Manager Settings 6

Maintenance 7

Troubleshooting 8

Appendix 9

Table of Contents

Index

2. Lift the paper stack cover and pull it out completely.

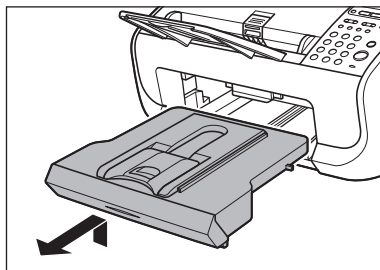

NOTE

Make sure the back end of the cover does not catch the front paper guide.

3. Lower the scanning platform (A) in the document delivery slot.

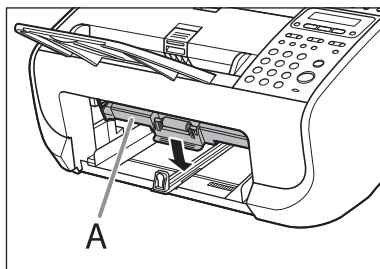

4. Carefully pull out the jammed document.

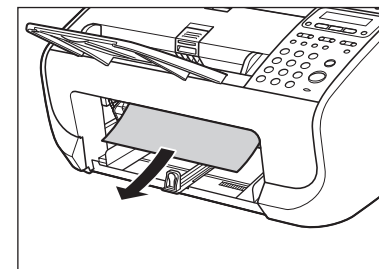

5. Lift the scanning platform back into place.

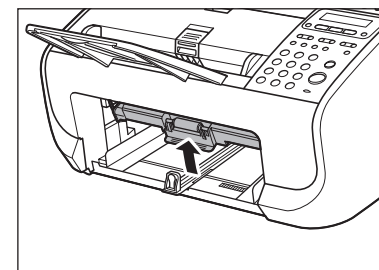



Back



Previous



Next

TOP

- Before Using the Machine 1
- Document and Paper 2
- Sending and Receiving 3
- Copying 4
- Printing (FAX-L160 Only) 5
- System Manager Settings 6
- Maintenance 7
- Troubleshooting 8
- Appendix 9

6. Insert the paper stack cover.

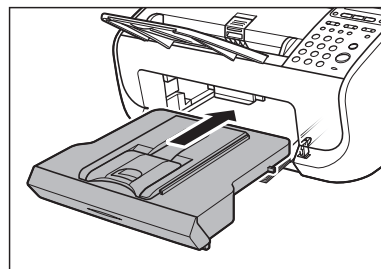

NOTE

Make sure the back end of the cover does not catch and lower the scanning platform.

7. Lower the document release lever back into place.

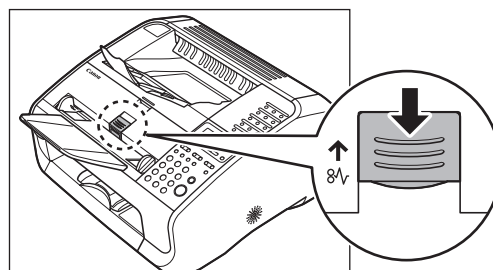

Paper Jams

When <PAPER JAM/OPEN TONER COVER> appears on the LCD display, remove jammed paper from the inside of the machine first, then from the paper feeder if necessary.

1. Close the paper delivery tray extension (A), and then the paper delivery tray (B) itself.

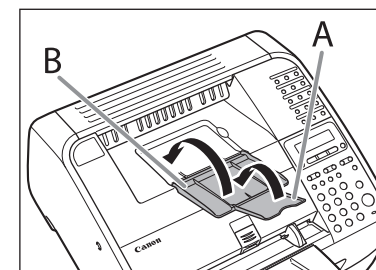

CAUTION

Do not close the paper delivery tray without folding the extension first.

- Table of Contents
- Index



Back



Previous



Next

TOP

Before Using the Machine 1

Document and Paper 2

Sending and Receiving 3

Copying 4

Printing (FAX-L160 Only) 5

System Manager Settings 6

Maintenance 7

Troubleshooting 8

Appendix 9

Table of Contents

Index

2. Open the toner cover by the notch (A).

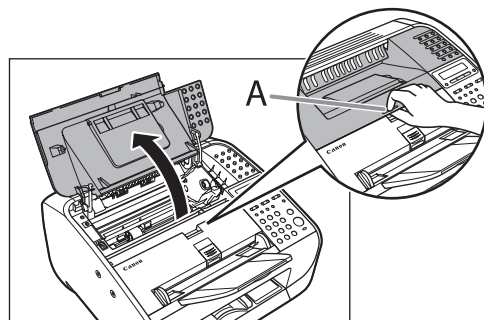

CAUTION

Always open the toner cover first before removing jammed paper inside the machine.

3. Remove the toner cartridge.

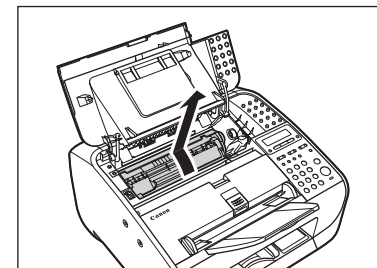

CAUTION

- To avoid exposing the toner cartridge to light, place it in its protective bag or wrap it in a thick cloth.
- Do not open the drum protective shutter (A).

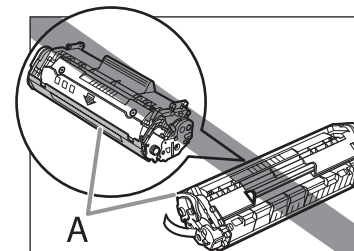

NOTE

Always hold the toner cartridge by its handle.



Back



Previous



Next

TOP

Before Using the Machine 1

Document and Paper 2

Sending and Receiving 3

Copying 4

Printing (FAX-L160 Only) 5

System Manager Settings 6

Maintenance 7

Troubleshooting 8

Appendix 9

4. Gently pull jammed paper out of the machine.

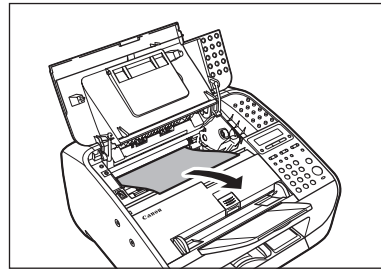

CAUTION

- Do not touch the fixing assembly (A) as it becomes very hot during use.
- Do not touch the pins (B) or the transfer roller (C) as this can damage the machine.

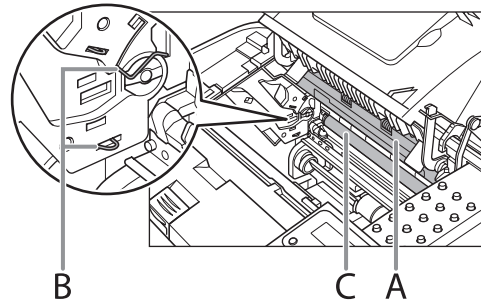

- If you tear the paper, remove any torn pieces to avoid further jams.
- If loose toner comes into contact with your skin or clothing, wash with cold water. Warm water will set the toner.

5. Hold the toner cartridge by its handle (A).

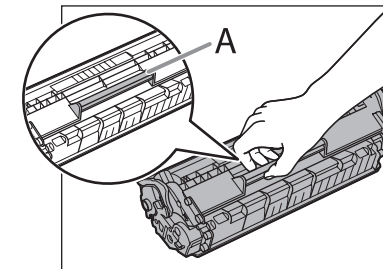

6. The arrow (A) on the toner cartridge should be facing away from you and pointing down.

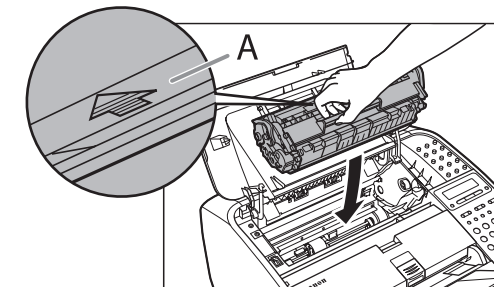

Table of Contents

Index



Back



Previous



Next

- Before Using the Machine **1**
- Document and Paper **2**
- Sending and Receiving **3**
- Copying **4**
- Printing (FAX-L160 Only) **5**
- System Manager Settings **6**
- Maintenance **7**
- Troubleshooting **8**
- Appendix **9**

- 7. Insert the toner cartridge so that the guide (A) on the left side of the toner cartridge fits into the groove inside the machine and slide it down parallel to the guide.**

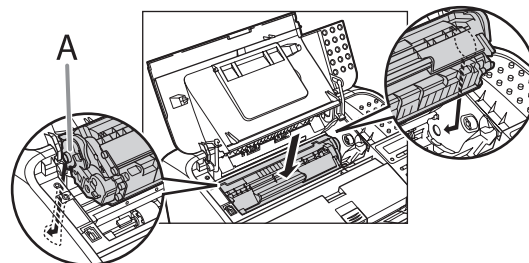

- 8. Push the toner cartridge to make sure it is properly set in the machine.**

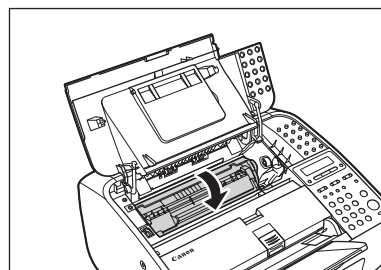

- 9. Close the toner cover.**

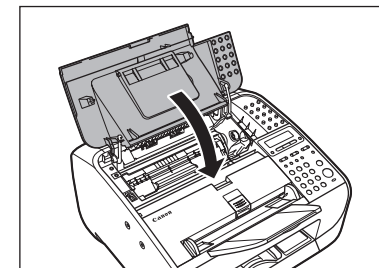

NOTE

Be careful not to get your fingers caught.

- 10. Open the paper delivery tray (A) and the extension (B).**

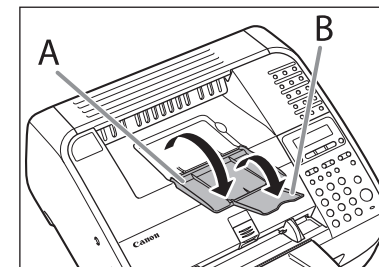

- Table of Contents
- Index



Back



Previous



Next

TOP

Before Using the Machine 1

Document and Paper 2

Sending and Receiving 3

Copying 4

Printing (FAX-L160 Only) 5

System Manager Settings 6

Maintenance 7

Troubleshooting 8

Appendix 9

Table of Contents

Index

11. Lift the paper stack cover and pull it out completely.

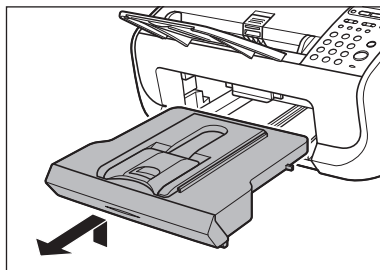

NOTE

Make sure the back end of the cover does not catch the front paper guide.

12. Carefully pull jammed paper from inside the slot.

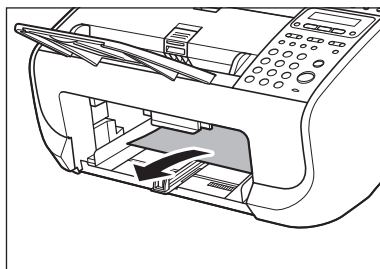

NOTE

If you tear the paper, remove any torn pieces to avoid further jams.

13. Insert the paper stack cover.

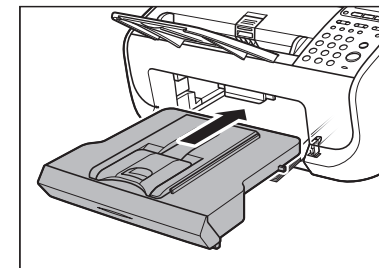

NOTE

Make sure the back end of the cover does not catch and lower the scanning platform.



Back



Previous



Next

TOP

- Before Using the Machine 1
- Document and Paper 2
- Sending and Receiving 3
- Copying 4
- Printing (FAX-L160 Only) 5
- System Manager Settings 6
- Maintenance 7
- Troubleshooting 8
- Appendix 9

LCD Messages

See the following when the LCD displays error and status messages.

ALREADY REGISTERED

Description The same recipient was entered twice.

Action Select a different recipient.

AVAILABLE MEMORY

nn%

Description This message shows the percentage of the memory currently available.

Action If you need more space, wait for the machine to send any documents in memory. Also print, send, or delete any documents stored in memory.

CANNOT PRINT RX DATA

Description The machine temporarily received the fax in memory because an error of some kind has occurred in the machine.

This error message appears with one of the messages below.

- <CLOSE COVER/TONER COVER>
- <LOAD CORRECT PAPER>
- <TONER LOW/PREPARE NEW TONER>
- <SET PAPER AGAIN/SET TONER AGAIN>
- <PAPER JAM /OPEN TONER COVER>
- <LOAD PAPER>

Action This error message appears with another message. When the error is resolved, the received data will be printed out. For how to solve the problem, see the action for the messages displayed with it.

- Table of Contents
- Index



Back



Previous



Next

TOP

Before Using the Machine 1

Document and Paper 2

Sending and Receiving 3

Copying 4

Printing (FAX-L160 Only) 5

System Manager Settings 6

Maintenance 7

Troubleshooting 8

Appendix 9

Table of Contents

Index

CANNOT REGIST MORE

Description The number of entered recipients for broadcasting has already reached the upper limit (131).

Action Send the document separately.

Description The number of registered recipients for group dialing has already reached the upper limit (50).

Action Register a different one-touch speed dialing key for group dialing.

Description The number of memory stored in Polling TX has already reached the upper limit (30).

Action Wait for the sending to complete or delete the unnecessary documents.

Description The number of entered recipients for Polling RX has already reached the upper limit (131).

Action Send the document separately.

CANNOT USE FUNCTION

Description Redialing is not available with [Redial/Pause]. This message appears when <RESTRICT REDIAL> is set to <ON> in the <ACCESS TO DEST.> of the <SYSTEM SETTINGS> menu.

Action Dial the number manually.

CHECK DOCUMENT

Description A document jam may have occurred in the ADF.

Action Remove the jammed document.

Description The document is longer than 400 mm.

Action Reduce the length of the document to within 400 mm, then try again.

CHECK DESTINATION

Description The fax number entered at the second time is different from the one entered at the first time. This message appears when <CONFIRM FAX NO.> is set to <ON> in the <ACCESS TO DEST.> of the <SYSTEM SETTINGS> menu.

Action Check if the fax number is correct, then enter the same fax number as the first one after pressing [Start].

CHECK SCANNING AREA

Description The scanning platform is dirty, or not set into scanning position.

Action Clean the scanning area, or lift the scanning platform into place.



Back



Previous



Next

TOP

Before Using the Machine 1

Document and Paper 2

Sending and Receiving 3

Copying 4

Printing (FAX-L160 Only) 5

System Manager Settings 6

Maintenance 7

Troubleshooting 8

Appendix 9

CLOSE COVER TONER COVER

Description The toner cover is not closed completely.

Action Check the toner cover, and make sure that it is completely closed.

HANG UP PHONE

Description The optional handset or the external telephone is off the hook.

Action Hang up the optional handset or the external telephone.

INITIALIZING...

Description This message appears when connecting the power cord, or when the machine is not ready for printing.

Action Wait until the message disappears.

LOAD CORRECT PAPER

Description The size of the paper in the paper feeder is different from that of the paper specified in <CASSETTE> of the <PAPER SETTINGS> menu.

Action Load the correct size paper or change the paper size in <CASSETTE> of the <PAPER SETTINGS> menu. For more information, see "If <LOAD CORRECT PAPER> is displayed," on p. 8-18.

LOAD PAPER

Description No paper is loaded in the paper feeder.

Action Load paper correctly. Then press [OK] when using the paper feeder.

LOST IMAGE

Description The machine was turned off when any documents were stored in the machines memory. Please note that any data stored in the memory, including received fax documents, will be deleted if you disconnect the power cord of the machine.

Action The error is automatically released after two seconds, and the machine automatically prints out the lost report that shows the records still existing in the activity report.

Table of Contents

Index



Back



Previous



Next

TOP

Before Using the Machine 1

Document and Paper 2

Sending and Receiving 3

Copying 4

Printing (FAX-L160 Only) 5

System Manager Settings 6

Maintenance 7

Troubleshooting 8

Appendix 9

Table of Contents

Index

MEMORY FULL

Description	The machine is full of jobs.
Action	Print, send, or delete any documents stored in memory.
Action	Divide the document stack into a few parts and try again one by one.
Action	Send the document with low resolution.
Description	The number of TX/RX jobs that can be stored in memory reached the maximum.
Action	The maximum numbers of jobs that can be stored in memory are as follows (Based on the condition that the other party sends the fax by FAX-L160 with ITU-T Standard Chart No.1, mode); Up to 256 jobs for sending and receiving. Wait for the machine to send any documents in memory. Also print, send, or delete any documents stored in memory.

NOT AVAILABLE

Description	You pressed the one-touch speed dialing key or coded speed dialing that has already been registered, when you are registering group dialing.
Description	You pressed the group dialing that has already been registered, when you are registering a one-touch speed dialing or coded speed dialing.
Action	Register the one-touch speed dialing key or coded speed dialing that is not used.
Description	The number of entered recipients for broadcasting by the numeric keys has already reached the upper limit (16).
Action	Enter not more than 16 recipients for broadcasting by the numeric keys.
Description	You have specified the group dialing when the line is off the hook or [Hook] key is pressed.
Action	Specify the recipient other than group dialing.
Description	A group dialing key is used for Relay TX.
Action	Enter the recipients except group dialing keys.



Back



Previous



Next

TOP

Before Using the Machine 1

Document and Paper 2

Sending and Receiving 3

Copying 4

Printing (FAX-L160 Only) 5

System Manager Settings 6

Maintenance 7

Troubleshooting 8

Appendix 9

NOT REGISTERED

Description No destination is registered for the one-touch speed dialing key or coded speed dialing you pressed.

Action Register the destinations before using the Address Book function.

OUT OF TONER CHANGE TONER

Description Toner has run out.

Action Install a new cartridge.

PAPER JAM OPEN TONER COVER

Description Paper jams have occurred in the machine.

Action Clear the paper jam (See "Paper Jams," on p. 8-5.) and reload paper in the paper feeder.

PRINTER DATA ERROR* CHECK PRINTER

Description The data from the PC was not printed.

Action Check if the software is installed properly or if the printer cable is properly connected.

Action Check if the memory is full.

* Only for the FAX-L160.

REGISTERING KEY CANNOT REGISTER

Description The selected one-touch speed dialing key is already used as the group dialing key it is being assigned to.

Action Select a different one-touch speed dialing key.

SET DOCUMENT

Description No document was set on the machine when [Start] was pressed. (in the copy/fax mode)

Action Set a document.

Table of Contents

Index



Back



Previous



Next

- Before Using the Machine 1
- Document and Paper 2
- Sending and Receiving 3
- Copying 4
- Printing (FAX-L160 Only) 5
- System Manager Settings 6
- Maintenance 7
- Troubleshooting 8
- Appendix 9

**SYSTEM ERROR
EXXX**

Description A system error has occurred. <XXX> will be a three-digit code that indicates a particular type of error.

Action Unplug the machine. Wait for at least 5 seconds and reconnect the power cord. If the message persists, disconnect the power cord, and contact your local authorized Canon dealer or the Canon help line.

**SET PAPER AGAIN
SET TONER AGAIN**

Description Paper is not loaded properly, or the toner cartridge is not set.

Action Load paper properly. (For instructions on how to load paper in the paper feeder, see "Set Up the Machine" in the Starter Guide.
Set the toner cartridge in the machine. For details, see "Set Up the Machine" in the Starter Guide.

**TONER LOW
PREPARE NEW TONER**

Description The toner is running low.

Action Prepare a new toner cartridge.

WRONG NUMBER ENTRY

Description An invalid number was entered in the date and time setting.

Action Enter a correct date or time.

WRONG PASSWORD

Description The memory lock reception password or system password you entered is incorrect.

Action Enter the correct password.
For details, see "Receiving Features" on p. 3-24 or "Specifying the System Manager Settings," on p. 6-2.



Back



Previous



Next

TOP

Before Using the Machine 1

Document and Paper 2

Sending and Receiving 3

Copying 4

Printing (FAX-L160 Only) 5

System Manager Settings 6

Maintenance 7

Troubleshooting 8

Appendix 9

Table of Contents

Index

0001

Description The sender may not be using a G3 fax machine.

Action Make sure the sender's machine is compatible with your machine.

0070

Description Reception was manually canceled on the machine.

Action Ask the sender to resend the document if necessary.

0071

Description The machine's memory is full.

Action Print, send, or delete any documents stored in memory.

0080

Description The recipient's machine did not respond within 35 seconds.

Action Resend the document. Ask the other party to check their machine. If you are making an overseas call, add a pause to the number.

008D

Description The recipient's machine has run out of paper.

Action Ask the recipient to make sure that paper is loaded in their machine.

00A0

Description Transmission was manually canceled on the machine.

Action Resend the document if necessary.

00A1

Description There is a document jam.

Action Clear the document jam.

00FF

Description All redialing attempts have failed.

Action Check if the recipient's number is correct or the telephone cable is properly connected, and try again.



Back



Previous



Next

TOP

Before Using the Machine 1

Document and Paper 2

Sending and Receiving 3

Copying 4

Printing (FAX-L160 Only) 5

System Manager Settings 6

Maintenance 7

Troubleshooting 8

Appendix 9

If <LOAD CORRECT PAPER> is displayed

When <LOAD CORRECT PAPER> appears on the LCD display, the size of the paper in the paper feeder is different from that of the paper specified in <CASSETTE> of the <PAPER SETTINGS> menu. You need to load the correct size paper or change the paper size in <CASSETTE> of the <PAPER SETTINGS> menu.



NOTE

- For print jobs, you need to specify the paper size from your computer.
- For copy jobs, <LOAD CORRECT PAPER> disappears automatically. Load the correct size paper or change the paper size setting. (See “Setting Paper Size and Type,” on p. 2-11.)

■ Re-Loading the Paper

1. **Load the correct size paper as shown on LCD display, then press [OK] to resume the job.**

The machine re-starts printing.

■ Changing the Paper Size Setting

1. Press [Menu].
2. Press [◀-] or [+▶] to select <PAPER SETTINGS>, then press [OK].

3. Press [◀-] or [+▶] to select <CASSETTE>, then press [OK].
4. Press [◀-] or [+▶] to select <PAPER SIZE>, then press [OK].
5. Press [◀-] or [+▶] to select the paper size same as paper loaded into the machine, then press [OK].
6. Press [Stop/Reset] to return to the standby mode.
7. Press [OK] to resume the job.
No further operation is required.

Table of Contents

Index



Back



Previous



Next

TOP

Before Using the Machine 1

Document and Paper 2

Sending and Receiving 3

Copying 4

Printing (FAX-L160 Only) 5

System Manager Settings 6

Maintenance 7

Troubleshooting 8

Appendix 9

Table of Contents

Index

General Problems

The machine has no power.

Q Is the power cord plugged in securely?

A Check that the power cord is securely plugged into the machine and into the wall outlet. If the machine is plugged into a power strip, make sure the power strip is plugged in and turned on.

Q Is the power cord supplying power?

A Use a different power cord, or test the cord for continuity using a voltmeter.

Nothing appears in the LCD.

Q Is the power cord plugged in securely?

A Check that the power cord is securely plugged into the machine and into the wall outlet. If the machine is plugged into a power strip, make sure the power strip is plugged in and turned on.

Q Is the machine in the Sleep mode?

A Press [Energy Saver] on the operation panel to cancel the Sleep mode.



Back



Previous



Next

TOP

- Before Using the Machine **1**
- Document and Paper **2**
- Sending and Receiving **3**
- Copying **4**
- Printing (FAX-L160 Only) **5**
- System Manager Settings **6**
- Maintenance **7**
- Troubleshooting **8**
- Appendix **9**

Paper Feeding Problems

Paper does not feed properly.

- Q** Is the paper loaded correctly?

A Make sure the paper is correctly loaded. (See "Set Up the Machine," in the Starter Guide.)
- Q** Does the machine contain too many sheets?

A Make sure you load the correct quantity. (See "Paper Requirements," on p. 2-5.)

Multiple sheets feed together into the machine.

- Q** Is the paper loaded correctly?

A Make sure the paper is correctly loaded. (See "Set Up the Machine," in the Starter Guide.)
- Q** Does the machine contain too many sheets?

A Make sure you load the correct quantity. (See "Paper Requirements," on p. 2-5.)

- Q** Are different types of paper loaded in the machine?

A Load only one type of paper.

A Make sure you load paper that meets the requirements for use. (See "Paper Requirements," on p. 2-5.)

A Let the paper run out before refilling the machine. Avoid mixing new stock with paper already loaded.

Repeated paper jams occur.

- Q** Is the correct type of paper loaded in the machine?

A Make sure you load paper that meets the requirements for use. (See "Paper Requirements," on p. 2-5.)

- Table of Contents
- Index



Back



Previous



Next

TOP

Before Using the Machine 1

Document and Paper 2

Sending and Receiving 3

Copying 4

Printing (FAX-L160 Only) 5

System Manager Settings 6

Maintenance 7

Troubleshooting 8

Appendix 9

Table of Contents

Index

Sending/Receiving Problems

■ Sending Problems

Cannot send a fax.

Q Is the machine set for the correct telephone line type?

A Make sure the machine is set for the correct telephone line type. (See "Before FAX Setting," in the Starter Guide.)

Q Is the document loaded correctly?

A Make sure the document is correctly loaded. (See "Loading Documents," on p. 2-4.)

A Make sure the scanning platform is fully closed. (See "Paper Jams," on p. 8-5.)

Q Is the one-touch speed dialing key or coded speed dialing code you entered registered correctly?

A Check that the Address Book settings are registered correctly. (See "Storing/Editing Address Book," on p. 3-7.)

Q Did you dial the correct number?

A Check that you have the correct number.

Q Is the machine in the Sleep mode?

A The machine does not scan documents if it is in the Sleep mode. To take the machine out of the Sleep mode, press [Energy Saver] on the operation panel.

Q Is the recipient's machine out of paper?

A Ask the recipient to make sure paper is loaded in the machine.



Back



Previous



Next

TOP

Before Using the Machine 1

Document and Paper 2

Sending and Receiving 3

Copying 4

Printing (FAX-L160 Only) 5

System Manager Settings 6

Maintenance 7

Troubleshooting 8

Appendix 9

Table of Contents

Index

Q

Are there other documents being sent from memory?

A

Allow time for the documents to finish sending.

Q

Has an error occurred during transmission?

A

Check the LCD for an error message. (See "LCD Messages," on p. 8-10.)

A

Print an Activity Report and check for an error. (See "ACTIVITY REPORT," on p. 9-21.)

Q

Is the telephone cable connected properly?

A

Make sure the cable is connected properly. (See "Before FAX Setting," in the Starter Guide.)

Q

Is the telephone line working properly?

A

Make sure there is a dial tone when you press [Hook] or when you lift the optional handset or the handset of any external telephone connected to the machine. If there is no dial tone, contact your local telephone company.

Q

Is the recipient's machine a G3 fax machine?

A

Make sure the recipient's machine is compatible with your machine.

Q

Did the recipient's machine answer within 35 seconds (after all automatic redialing attempts)?

A

Ask the recipient to check the machine. For an overseas call, add pauses to the registered number. (See "Dialing an Overseas Number (With Pauses)," on p. 3-21.)

Q

Is the Processing/Data indicator lit?

A

The external phone is busy. Please wait until the external phone becomes free.

Q

Is the machine overheated?

A

Unplug the machine and let it cool for about 5 minutes. Then plug in the machine and try sending again.



Back



Previous



Next

TOP

Before Using the Machine 1

Document and Paper 2

Sending and Receiving 3

Copying 4

Printing (FAX-L160 Only) 5

System Manager Settings 6

Maintenance 7

Troubleshooting 8

Appendix 9

Memory fills up immediately when you try to send.

Q Are you sending with the resolution set to <SUPER FINE>?

A If you want to keep your document quality, divide the document into some parts and send them separately.

A If your document does not contain fine text or photographs, set the resolution to <STANDARD>.

A If your document contains fine text or photographs, send it directly rather than using a memory transmission.

Q Is a document stored in memory, leaving little memory available?

A Print, send, or delete any documents stored in memory.

Faxes sent from the machine are spotted or dirty.

Q Is the recipient's machine working properly?

A Check the machine by making a copy. If the copy is clear, the problem may be in the recipient's machine. If the copy is spotted or dirty, clean the scanner components. (See "Scanning Area," on p. 2-3.)

Q Is the document loaded correctly?

A Make sure the document is correctly loaded. (See "Loading Documents," on p. 2-4.)

The documents you sent are too light.

Q Is the density setting changed to be lighter?

A Adjust the density for light documents to be darker. (See "Density," on p. 3-6.)

Q Are the scanning components of the machine clean?

A If the received document is spotted or dirty, clean the scanning components. (See "Scanning area," on p. 7-6.)

Table of Contents

Index



Back



Previous



Next

TOP

- Before Using the Machine 1
- Document and Paper 2
- Sending and Receiving 3
- Copying 4
- Printing (FAX-L160 Only) 5
- System Manager Settings 6
- Maintenance 7
- Troubleshooting 8
- Appendix 9

Sending of documents is too slow.

- Q** Is the resolution set to <FINE>, <PHOTO> or <SUPER FINE>?
- A** Setting the resolution to <STANDARD> reduces the sending time.

Errors occur frequently while sending.

- Q** Are the telephone lines in poor condition, or do you have a bad connection?
- A** Check if there is a device nearby that interferes with signal transmission (e.g., microwave oven).

Cannot redial with [Redial/Pause].

- Q** Is <RESTRICT REDIAL> set to <ON>?
- A** When <RESTRICT REDIAL> is set to <ON>, Redialing is not available. (See "Restricting Redial," on p. 6-3.)

Entering the fax number is required again after pressing [Start].

- Q** Is <CONFIRM FAX NO.> set to <ON>?
- A** When <CONFIRM FAX NO.> is set to <ON>, you need to enter the fax number again after pressing [Start]. (See "Confirming Entered Fax Numbers," on p. 6-3.)

Receiving Problems

Cannot receive a fax automatically.

- Q** Is the machine set to receive automatically?
- A** For the machine to receive faxes automatically, the receive mode must be set to <FaxOnly>, <FaxTel>, or <AnsMode>. If you have set <AnsMode>, confirm that an external telephone with answering system or answering machine is connected to the machine and that it is turned on with an outgoing message properly recorded. (See "Basic Receiving Method," on p. 3-23.)

- Table of Contents
- Index



Back



Previous



Next

TOP

Before Using the Machine 1

Document and Paper 2

Sending and Receiving 3

Copying 4

Printing (FAX-L160 Only) 5

System Manager Settings 6

Maintenance 7

Troubleshooting 8

Appendix 9

Table of Contents

Index

Q Are documents stored in memory, leaving little or no memory available?

A Print, send, or delete any documents stored in memory.

Q Has an error occurred during reception?

A Check the LCD for an error message. (See "LCD Messages," on p. 8-10.)

A Print an Activity Report and check for an error. (See "ACTIVITY REPORT," on p. 9-21.)

Q Is paper loaded in the machine?

A Make sure paper is loaded in the machine. (See "Set Up the Machine," in the Starter Guide.)

Q Is the telephone cable connected properly?

A Make sure the cable is connected properly. (See "Before FAX Setting," in the Starter Guide.)

No automatic switching between telephone and fax calls.

Q Is the machine set to switch automatically between telephone and fax calls?

A For the machine to switch between fax and telephone calls automatically, the receive mode must be set to <FaxTel>, or <AnsMode>. If you have set <AnsMode>, confirm that an answering machine is connected to the machine and that it is turned on with an outgoing message properly recorded. (See "Basic Receiving Method," on p. 3-23.)

Q Are documents stored in memory, leaving little or no memory available?

A Print, send, or delete any documents stored in memory.

Q Has an error occurred during reception?

A Check the LCD for an error message. (See "LCD Messages," on p. 8-10.)

A Print an Activity Report and check for an error. (See "ACTIVITY REPORT," on p. 9-21.)



Back



Previous



Next

TOP

Before Using the Machine 1

Document and Paper 2

Sending and Receiving 3

Copying 4

Printing (FAX-L160 Only) 5

System Manager Settings 6

Maintenance 7

Troubleshooting 8

Appendix 9

Table of Contents

Index

Q Is paper loaded in the machine?

A Make sure paper is loaded in the machine. (See "Set Up the Machine," in the Starter Guide.)

Q Can the sender's machine send the CNG signal, which tells your machine that the incoming call is a fax call?

A Some machines cannot send this signal. In such cases, receive the fax manually.

Cannot receive a document manually.

Q Is the machine set to receive manually?

A For the machine to receive faxes manually, the receive mode must be set to <Manual>. (See "Basic Receiving Method," on p. 3-23.)

Q Did you hang up the optional handset or the external telephone before pressing [Start] or dialing the remote reception ID?

A Always press [Start] or dial the remote reception ID before hanging up. Otherwise you will disconnect the call.

Q Are documents set on the ADF?

A After removing the document from the ADF, please attempt manual receiving again. If you press [Start] when documents are set on the ADF, it automatically switches to manual sending.

Print quality is poor.

Q Is the toner low or unevenly distributed?

A Redistribute the toner inside the toner cartridge. If the problem persists, replace the toner cartridge. (See "Replacing the Toner Cartridge," on p. 7-8.)

Q Is the correct type of paper loaded in the machine?

A Make sure you load paper that meets the requirements for use. (See "Paper Requirements," on p. 2-5.)

Q Is the sender's machine functioning properly?

A Ask the sender to check that the scanning components of the machine are clean.



Back



Previous



Next

TOP

Before Using the Machine 1

Document and Paper 2

Sending and Receiving 3

Copying 4

Printing (FAX-L160 Only) 5

System Manager Settings 6

Maintenance 7

Troubleshooting 8

Appendix 9

Table of Contents

Index

Q Is the machine in the toner saver mode?

A Set <TONER SAVER MODE> to <OFF>. (See "COMMON SETTINGS," on p. 9-6.)

Faxes do not print.

Q Have you removed the plastic seal from the toner cartridge?

A Make sure you remove the seal from the toner cartridge. (See "Set Up the Machine," in the Starter Guide.)

Q Is the toner cartridge installed properly?

A Make sure the toner cartridge is installed properly. (See "Set Up the Machine," in the Starter Guide.)

Q Is the cartridge out of toner?

A Replace the toner cartridge. (See "Replacing the Toner Cartridge," on p. 7-8.)

Q Is the correct size of paper loaded in the machine?

A Make sure you load paper that meets the requirements for use. (See "Paper Requirements," on p. 2-5.)

A Change <PAPER SETTINGS>. (See "Setting Paper Size and Type," on p. 2-11.)

Received faxes print blotched or unevenly.

Q Is the sender's machine functioning properly?

A Ask the sender to check that the scanning components of the machine are clean.



Back



Previous



Next

TOP

Before Using the Machine 1

Document and Paper 2

Sending and Receiving 3

Copying 4

Printing (FAX-L160 Only) 5

System Manager Settings 6

Maintenance 7

Troubleshooting 8

Appendix 9

Part of the documents you receive are cut off.

Q Are the slide guides of the paper feeder set to the size of the paper?

A Adjust the guides of the paper feeder to the size of the paper.

Q Have you specified the correct paper size for the paper feeder?

A Specify the correct paper size for the paper feeder.

Q Is the toner low or unevenly distributed?

A Redistribute the toner inside the toner cartridge. If the problem persists, replace the toner cartridge. (See "Replacing the Toner Cartridge," on p. 7-8.)

Q Is the printing method for received documents set to <CUT>?

A If you want to print a received document without cutting off the end, set the printing method to <ON> or <OFF>. (See "Received Image Reduction," on p. 3-29.)

Cannot receive using Error Correction Mode (ECM).

Q Does the sender's machine support ECM?

A If the sender's machine does not support ECM, the document is received in normal mode without error checking.

Receiving of documents is too slow.

Q Is the resolution of the sender's machine set higher?

A Contact to the sender and make sure the resolution of the sender's machine has been set properly.

Table of Contents

Index



Back



Previous



Next

TOP

Before Using the Machine 1

Document and Paper 2

Sending and Receiving 3

Copying 4

Printing (FAX-L160 Only) 5

System Manager Settings 6

Maintenance 7

Troubleshooting 8

Appendix 9

Table of Contents

Index

You cannot get documents from information services.

Q Is your machine set to the tone dialing type of the telephone line?

A Press [Tone] to set the tone dialing.

Q Do you receive messages from the information services such as to press [Start] after the beep to receive?

A When you hear the beep sound, press [Start].

Errors occur frequently while receiving.

Q Are the telephone lines in poor condition, or do you have a bad connection?

A Check if there is a device nearby that interferes with signal reception (e.g., microwave oven).

Q

Is the sender's machine functioning properly?

A

Ask the sender to check that the machine is functioning properly.



Back



Previous



Next

TOP

Before Using the Machine 1

Document and Paper 2

Sending and Receiving 3

Copying 4

Printing (FAX-L160 Only) 5

System Manager Settings 6

Maintenance 7

Troubleshooting 8

Appendix 9

Table of Contents

Index

Copying Problems

Blank paper comes out from the machine.

- Q** Have you removed the plastic seal from the toner cartridge?
- A** Make sure you remove the seal from the cartridge. (See "Set Up the Machine," in the Starter Guide.)
- Q** Is the toner cartridge installed properly?
- A** Make sure the toner cartridge is installed properly. (See "Set Up the Machine," in the Starter Guide.)
- Q** Is the cartridge out of toner?
- A** Replace the toner cartridge. (See "Replacing the Toner Cartridge," on p. 7-8.)
- Q** Does the document meet the requirements for the machine?
- A** Make sure you load documents that meet the requirements for use. (See Chapter 2, "Document Requirements," on p. 2-2.)

Copy is too light or has uneven density.

- Q** Is the toner low or unevenly distributed?
- A** Redistribute the toner inside the toner cartridge. If the problem persists, replace the toner cartridge. (See "Replacing the Toner Cartridge," on p. 7-8.)

Copy has vertical white streaks.

- Q** Is the toner low or unevenly distributed?
- A** Redistribute the toner inside the toner cartridge. If the problem persists, replace the toner cartridge. (See "Replacing the Toner Cartridge," on p. 7-8.)

Copy is spotted or dirty.

- A** If the copy is spotted or dirty, clean the scanning components and machine's interior (See "Cleaning the Machine," on p. 7-2.)



Back



Previous



Next

TOP

Before Using the Machine 1

Document and Paper 2

Sending and Receiving 3

Copying 4

Printing (FAX-L160 Only) 5

System Manager Settings 6

Maintenance 7

Troubleshooting 8

Appendix 9

Paper jams occur.

A Make sure the scanning platform is fully closed. (See "Paper Jams," on p. 8-5.)

Q **Is the paper loaded correctly?**

A Make sure the document is correctly loaded. (See "Set Up the Machine," in the Starter Guide.)

Q **Is the correct type of paper loaded in the machine?**

A Make sure you load paper that meets the requirements for use. (See "Paper Requirements," on p. 2-5.)

Copy is skewed.

Q **Is the paper loaded correctly?**

A Make sure the paper is correctly loaded in the machine. (See "Set Up the Machine," in the Starter Guide.)

Copy is not clear.

Q **Is the correct type of paper loaded in the machine?**

A Make sure you load paper that meets the requirements for use. (See "Paper Requirements," on p. 2-5.)

Q **Are you copying on the wrong side of the paper?**

A Some papers have a "right" side for copying. If the copy quality is not as clear as you think it should be, try copying on the other side of the paper.

Table of Contents

Index



Back



Previous



Next

TOP

Before Using the Machine 1

Document and Paper 2

Sending and Receiving 3

Copying 4

Printing (FAX-L160 Only) 5

System Manager Settings 6

Maintenance 7

Troubleshooting 8

Appendix 9

Table of Contents

Index

Printing Problems (FAX-L160 Only)

Nothing prints.

Q Is the power cord plugged in securely?

A Check that the power cord is securely plugged into the machine and into the wall outlet. If the machine is plugged into a power strip, make sure the power strip is plugged in and turned on.

Blank paper comes out from the machine.

Q Have you removed the plastic seal from the toner cartridge?

A Make sure you remove the seal from the toner cartridge. (See "Set Up the Machine," in the Starter Guide.)

Q Is the toner cartridge installed properly?

A Make sure the toner cartridge is installed properly. (See "Set Up the Machine," in the Starter Guide.)

Q Is the toner cartridge out of toner?

A Replace the toner cartridge. (See "Replacing the Toner Cartridge," on p. 7-8.)

Printout is too light or has uneven density.

Q Is the toner low or unevenly distributed?

A Redistribute the toner inside the toner cartridge. If the problem persists, replace the toner cartridge. (See "Replacing the Toner Cartridge," on p. 7-8.)

Printout has vertical white streaks.

Q Is the toner low or unevenly distributed?

A Redistribute the toner inside the toner cartridge. If the problem persists, replace the toner cartridge. (See "Replacing the Toner Cartridge," on p. 7-8.)



Back



Previous



Next

- Before Using the Machine **1**
- Document and Paper **2**
- Sending and Receiving **3**
- Copying **4**
- Printing (FAX-L160 Only) **5**
- System Manager Settings **6**
- Maintenance **7**
- Troubleshooting **8**
- Appendix **9**

- Table of Contents
- Index

Printout is spotted or dirty.

A If the copy is spotted or dirty, clean the scanning components and machine's interior (See "Cleaning the Machine," on p. 7-2.)

Paper jams occur.

A Make sure the scanning platform is fully closed. (See "Paper Jams," on p. 8-5.)

Q Is the document loaded correctly?

A Make sure the document is correctly loaded. (See "Set Up the Machine," in the Starter Guide.)

Q Is the correct type of paper loaded in the machine?

A Make sure you load paper that meets the requirements for use. (See "Paper Requirements," on p. 2-5.)

Printout is skewed.

Q Is the paper loaded correctly?

A Make sure the paper is correctly loaded in the machine. (See "Set Up the Machine," in the Starter Guide.)

Printout is not clear.

Q Is the correct type of paper loaded in the machine?

A Make sure you load paper that meets the requirements for use. (See "Paper Requirements," on p. 2-5.)

Q Are you printing on the wrong side of the paper?

A Some papers have a "right" side for printing. If the printout quality is not as clear as you think it should be, try printing on the other side of the paper



Back



Previous



Next

- Before Using the Machine 1
- Document and Paper 2
- Sending and Receiving 3
- Copying 4
- Printing (FAX-L160 Only) 5
- System Manager Settings 6
- Maintenance 7
- Troubleshooting 8
- Appendix 9

Cannot print documents from a computer.

- Q

Is the printer driver properly installed?
- A

Make sure that the printer driver is properly installed.
- Q

Are the printer driver settings (Paper Size, Output Size) correct?
- A

Make sure that the printer driver settings (Paper Size, Output Size) are correct. ([See Online Help.](#))
- Q

Is the USB cable properly connected to the machine and the computer?
- A

Make sure that the USB cable is properly connected to the machine and the computer. Try a different USB cable.
- Q

Does the USB port you are using properly work?
- A

Restart your computer and the machine. If the computer has other ports, connect the USB cable to others.

- Q
- A

Are there any jobs remaining in the print queue?

- A print job may be stuck in the print queue when it could not be finished due to an expected interruption. When this happens, follow this procedure to delete any remaining print jobs, and then print the documents again.
1. Double-click the icon of the printer you installed.
 - For Windows Vista
Click [Start] on the Windows task bar → [Control Panel] → [Printers] under [Hardware and Sound].
 - For Windows 2000:
Click [Start] on the Windows task bar → [Settings] → [Printers].
 - For Windows XP Professional/Server 2003:
Click [start] on the Windows task bar → [Printers and Faxes].
 - For Windows XP Home Edition:
Click [start] on the Windows task bar → [Control Panel] → [Printers and Other Hardware] → [Printers and Faxes].
 2. Delete the print job.
 - For deleting all the print jobs:
Click [Printers] → [Cancel All Documents]
 - For the specified job:
Right-click the specified print job → [Cancel]



Back



Previous



Next

TOP

Before Using the Machine 1

Document and Paper 2

Sending and Receiving 3

Copying 4

Printing (FAX-L160 Only) 5

System Manager Settings 6

Maintenance 7

Troubleshooting 8

Appendix 9

Table of Contents

Index

Telephone Problems

Cannot dial.

Q Is the telephone cable connected properly?

A Make sure the cable is connected properly. (See "Before FAX Setting," in the Starter Guide.)

Q Is the power cord plugged in securely?

A Check that the power cord is securely plugged into the machine and into the wall outlet. If the machine is plugged into a power strip, make sure the power strip is plugged in and turned on.

Q Is the machine set for the correct telephone line type?

A Make sure the machine is set for the correct telephone line type. (See "Before FAX Setting," in the Starter Guide.)

Telephone disconnects while you are talking.

Q Is the telephone cable connected properly?

A Make sure the cable is connected properly. (See "Before FAX Setting," in the Starter Guide.)

Q Is the telephone cable defective?

A Use another cord.

Calls do not connect, or the wrong number is dialed.

Q Did you confirm the dial tone before entering the telephone number?

A Make sure to confirm the dial tone before entering a telephone number. If you enter the number before the dial tone can be heard, the call may not connect, or the wrong number may be dialed.



Back



Previous



Next

TOP

Before Using the Machine 1

Document and Paper 2

Sending and Receiving 3

Copying 4

Printing (FAX-L160 Only) 5

System Manager Settings 6

Maintenance 7

Troubleshooting 8

Appendix 9

Table of Contents

Index

If a Power Failure Occurs

If a power failure occurs, machine functions will be limited as follows:

- Depending on your telephone, you may not be able to make telephone calls.
- You can receive telephone calls from the optional handset or telephone connected to the machine.
- You cannot send, receive, or copy documents.

If power is suddenly lost due to a power failure or accidental unplugging, the machine may lose received data stored in memory. If this happens, the LCD displays <LOST IMAGE> when power is restored and automatically prints a Lost Report (unless the cartridge is empty or there is no paper in the machine) that lists the documents (received in the last 60 transactions) that were lost from memory as a result of the power cut.



Back



Previous



Next

TOP

Before Using the Machine 1

Document and Paper 2

Sending and Receiving 3

Copying 4

Printing (FAX-L160 Only) 5

System Manager Settings 6

Maintenance 7

Troubleshooting 8

Appendix 9

Table of Contents

Index

If You Cannot Solve a Problem

If you cannot solve the problem after having referred to the information in this chapter, contact your local authorized Canon dealer or the Canon help line. Please have the following information ready when you contact Canon:

- Product name (FAX-L160/FAX-L140)
- Serial number (On the label located at the back of the machine)
- Place of purchase
- Nature of problem
- Steps you have taken to solve the problem and the results

CAUTION

If the machine makes strange noises, emits smoke or odd odor, disconnect the power cord immediately, and contact your local authorized Canon dealer or the Canon help line. Do not attempt to disassemble or repair the machine yourself.

NOTE

Attempting to repair the machine yourself may void the limited warranty.



Back



Previous



Next

TOP

9 Appendix

Before Using the Machine 1

Document and Paper 2

Sending and Receiving 3

Copying 4

Printing (FAX-L160 Only) 5

System Manager Settings 6

Maintenance 7

Troubleshooting 8

Appendix 9

Table of Contents

Index

Machine Settings	9-3
Printing USER DATA LIST.....	9-3
Accessing the Setting Menu	9-3
Setting Menu	9-5
PAPER SETTINGS.....	9-5
VOLUME CONTROL.....	9-5
COMMON SETTINGS	9-6
COPY SETTINGS	9-6
FAX SETTINGS.....	9-7
ADDRESS BOOK SET.....	9-11
PRINTER SETTINGS (FAX-L160 Only).....	9-12
TIMER SETTINGS	9-13



Back



Previous



Next

TOP

- Before Using the Machine **1**
- Document and Paper **2**
- Sending and Receiving **3**
- Copying **4**
- Printing (FAX-L160 Only) **5**
- System Manager Settings **6**
- Maintenance **7**
- Troubleshooting **8**
- Appendix **9**

- Table of Contents
- Index

- ADJUST./CLEANING 9-14
- REPORT SETTINGS..... 9-14
- SYSTEM SETTINGS..... 9-16
- Summary of Reports and Lists9-18**
- Printing Reports Automatically9-19**
 - TX REPORT 9-19
 - RX REPORT 9-20
 - ACTIVITY REPORT 9-21
- Printing Reports and Lists Manually9-23**
- Checking Remaining Memory9-24**
- Checking Print and Scan Counts9-25**
- Glossary9-26**
- Index.....9-32**



Back



Previous



Next

TOP

Before Using the Machine 1

Document and Paper 2

Sending and Receiving 3

Copying 4

Printing (FAX-L160 Only) 5

System Manager Settings 6

Maintenance 7

Troubleshooting 8

Appendix 9

Machine Settings

You can adjust the machine settings from the Setting Menu to customize the way the machine works. To see the list of the current settings, print out USER DATA LIST.

■ Printing USER DATA LIST

1. Press [Menu].
2. Press [◀-] or [+▶] to select <REPORT SETTINGS>, then press [OK].
3. Press [◀-] or [+▶] to select <LIST PRINT>, then press [OK].
4. Press [◀-] or [+▶] to select <USER DATA LIST>, then press [OK].

Printing starts, and the screen automatically returns to the standby mode.

■ Accessing the Setting Menu

1. Press [Menu].
2. Press [◀-] or [+▶] to select the menu you want to access, then press [OK].

<PAPER SETTINGS>
 <VOLUME CONTROL>
 <COMMON SETTINGS>
 <COPY SETTINGS>
 <FAX SETTINGS>
 <ADDRESS BOOK SET.>
 <PRINTER SETTINGS>
 <TIMER SETTINGS>
 <ADJUST./CLEANING>
 <REPORT SETTINGS>
 <SYSTEM SETTINGS>

Table of Contents

Index



Back



Previous



Next

TOP

Before Using the Machine 1

Document and Paper 2

Sending and Receiving 3

Copying 4

Printing (FAX-L160 Only) 5

System Manager Settings 6

Maintenance 7

Troubleshooting 8

Appendix 9

Table of Contents

Index

3. Press [**←**] or [**→**] to select a submenu, then press [OK].



NOTE

For details on the submenu, see "Setting Menu," on p. 9-5.

4. To register the settings or go to a submenu item, press [OK].

5. When finished, press [Stop/Reset] to return to the standby mode.



NOTE

- If you press [Stop/Reset] before pressing [OK], the setting will not be registered.
- Press [Menu] to return to the previous display.



Back



Previous



Next

- Before Using the Machine **1**
- Document and Paper **2**
- Sending and Receiving **3**
- Copying **4**
- Printing (FAX-L160 Only) **5**
- System Manager Settings **6**
- Maintenance **7**
- Troubleshooting **8**
- Appendix **9**

Setting Menu

The default settings are indicated in bold text.



NOTE

Depending on the country of purchase, some settings may not be available.

PAPER SETTINGS	
Setting Item	Description
1. CASSETTE	Sets the paper size and type on the paper feeder. (See "Setting Paper Size and Type," on p. 2-11.)
1. PAPER SIZE	Sets the paper size from the following options: A4 , OFICIO, BRAZIL-OFICIO, MEXICO-OFICIO, FOLIO, GOVERNMENT-LETTER, GOVERNMENT-LEGAL, FOOLSCAP, LTR, LGL
2. PAPER TYPE	Sets the paper type from the following options: PLAIN PAPER , PLAIN PAPER L, HEAVY PAPER, HEAVY PAPER H, and TRANSPARENCY

VOLUME CONTROL	
Setting Item	Description
1. MONITOR VOLUME	Sets the volume for monitor tone during the fax transmission. (0-3 (2))
2. CALLING TONE	Sets the volume of the ring produced when the machine detects a call. (0-3 (2))
3. ENTRY TONE	Beeps when pressing the keys on the operation panel. (0-3 (2))
4. ERROR TONE	Beeps when an error (e.g., TX error) occurs. (0-3 (2))



Back



Previous



Next

Before Using the Machine 1

Document and Paper 2

Sending and Receiving 3

Copying 4

Printing (FAX-L160 Only) 5

System Manager Settings 6

Maintenance 7

Troubleshooting 8

Appendix 9

Table of Contents

Index

COMMON SETTINGS

Setting Item	Description
1. TONER SAVER MODE	Sets whether to reduce toner consumption. <ul style="list-style-type: none"> - OFF - ON * This function is not effective for print jobs.
2. DISPLAY LANGUAGE	Selects the language on the display. (See, "Appendix," in the Starter Guide.) ENGLISH , GERMAN, FRENCH, SPANISH, ITALIAN, SWEDISH, NORWEGIAN, DUTCH, FINNISH, DANISH, PORTUGUESE, CZECH, SLOVENE, HUNGARIAN, RUSSIAN, TURKISH, POLISH

COPY SETTINGS

Setting Item	Description
1. STANDARD SETTINGS	Sets the default setting for copying.
1. IMAGE QUALITY	Sets the document type for copying. <ul style="list-style-type: none"> - TEXT/PHOTO - TEXT - PHOTO
2. DENSITY	Sets the density for copying. <ul style="list-style-type: none"> - MANUAL (1-9 (5)) - AUTO
3. ZOOM RATIO	Sets the zoom ratio for copying. Enters the zoom ratio by 1% increments. (50%-200% (100%))



Back



Previous



Next

TOP

Before Using the Machine 1

Document and Paper 2

Sending and Receiving 3

Copying 4

Printing (FAX-L160 Only) 5

System Manager Settings 6

Maintenance 7

Troubleshooting 8

Appendix 9

Table of Contents

Index

FAX SETTINGS

Setting Item	Description
1. RX MODE	Selects the receive mode. (See "Set the Machine for Receiving Faxes," in the Starter Guide.) <ul style="list-style-type: none"> - FaxOnly - AnsMode - FaxTel - MANUAL
2. USER SETTINGS	Specifies the basic operation settings in the fax mode.
1. UNIT TELEPHONE #	Registers your fax number (max. 20 characters, including spaces). (See "Set the Machine for Sending Faxes," in the Starter Guide.)
2. UNIT NAME	Registers your name/company name (max. 32 characters, including spaces). (See "Set the Machine for Sending Faxes," in the Starter Guide.)
3. TX TERMINAL ID	Sets the options for sender information.
ON	Sender information is printed in small type at the top of each page.
OFF	Sender information is not printed.
4. TEL LINE TYPE	Selects the telephone line type. (See "Telephone Line Setting," on p. 1-13.) <ul style="list-style-type: none"> - TOUCH TONE - ROTARY PULSE
5. STANDARD SETTINGS	Sets the default setting for faxing.
1. DENSITY	Sets the default density for faxing. (1-9 (5))
2. IMAGE QUALITY	Sets the default image quality for faxing. <ul style="list-style-type: none"> - STANDARD - FINE - PHOTO - SUPER FINE



Back



Previous



Next

TOP

Before Using the Machine 1

Document and Paper 2

Sending and Receiving 3

Copying 4

Printing (FAX-L160 Only) 5

System Manager Settings 6

Maintenance 7

Troubleshooting 8

Appendix 9

Table of Contents

Index

FAX SETTINGS	
3. TX SETTINGS	Sets the transmission features.
1. AUTO REDIAL	Sets whether to redial automatically when the other line is busy or a transmission error occurs. (See "Redialing Automatically," on p. 3-20.)
ON	Customizes the redial operation.
1. REDIAL TIMES	Sets the number of retries. (1TIMES–10TIMES (2TIMES))
2. REDIAL INTERVAL	Sets period of time before redialing. (2MIN.–99MIN. (2MIN.))
OFF	After the first attempt at dialing fails, redialing is not attempted.
2. DIALING LINE CHCK	Sets whether to check the telephone line condition. – OFF – ON
4. RX SETTINGS	Sets the reception features.
1. FAX/TEL OPT. SET	Sets the optional items in the <FaxTel> mode. (See "FAX/TEL: Optional Settings," on p. 3-24.)
1. RING START TIME	Sets the time the machine takes to check whether a call is a fax or a voice call. (4SEC–30SEC (6SEC))
2. F/T RING TIME	Sets the ring length for voice calls. (10SEC–45SEC (22SEC))
3. F/T SWITCH ACTION	Selects whether the machine switches to the receive mode after the ring time has elapsed, or whether if disconnects the call. – RECEIVE – DISCONNECT



Back



Previous



Next

TOP

Before Using the Machine 1

Document and Paper 2

Sending and Receiving 3

Copying 4

Printing (FAX-L160 Only) 5

System Manager Settings 6

Maintenance 7

Troubleshooting 8

Appendix 9

Table of Contents

Index

FAX SETTINGS

2. INCOMING RING	Sets whether or not to activate the ring alert of the optional handset or external telephone if <RX MODE> is set to <FaxOnly>. Selecting <ON> allows you to learn the fax reception and answer voice calls if you pick up the optional handset or external telephone while it is ringing.
ON	The optional handset or external telephone rings.
RING COUNT	Sets the number of incoming rings before the machine answers. (1TIMES–16TIMES (2TIMES))
OFF	The optional handset or the external telephone does not ring. (In the Sleep mode, the optional handset or external telephone may ring one or two times.)
3. REMOTE RX	Sets whether to use remote receiving. (See “Remote Reception,” on p. 3-27.)
ON	The machine enables remote receiving.
REMOTE RX ID	You can dial a code on remote extension to start receiving a document. A combination of two characters using 0 to 9 (default: 25)
OFF	The machine disables remote receiving.
4. RX PRINT	Sets whether to store all received pages in memory before printing them out or print each page as it is received. (See “Selecting the Receive Mode for Printing,” on p. 3-28)
MEMORY RX	Prints after all the pages of the document are received.
PRINT RX	Prints each page as it is received.



Back



Previous



Next

TOP

- Before Using the Machine 1
- Document and Paper 2
- Sending and Receiving 3
- Copying 4
- Printing (FAX-L160 Only) 5
- System Manager Settings 6
- Maintenance 7
- Troubleshooting 8
- Appendix 9

- Table of Contents
- Index

FAX SETTINGS	
5. RX TERMINAL ID	Sets whether to insert the machine's fax number and the sender information on received faxes. - OFF - ON
6. RX RESTRICTION	You can reject faxes from senders with no fax/telephone number in their sender information. (See "Reception Restriction," on p. 3-29.)
OFF	All receptions are conducted.
ON	Receives the fax only from the sending fax machine that sends the TSI signal.
5. PRINTER SETTINGS	Sets the printer functions.
1. RX REDUCTION	Sets whether to reduce or truncate the image when a faxed page is larger than the size of paper loaded. (See "Received Image Reduction," on p. 3-29.)
ON	Reduces the image to fit on the size of paper loaded.
OFF	Retains the original size of the image.
CUT	The image that is larger than 1-page record area is cut and not recorded.
2. CONT. PRINTING	Sets whether to continue printing when toner has run out. This function is only for printing fax documents and reports. (See "Replacing the Toner Cartridge," on p. 7-8.) - OFF - ON



Back



Previous



Next

TOP

Before Using the Machine 1

Document and Paper 2

Sending and Receiving 3

Copying 4

Printing (FAX-L160 Only) 5

System Manager Settings 6

Maintenance 7

Troubleshooting 8

Appendix 9

Table of Contents

Index

ADDRESS BOOK SET.

Setting Item	Description
1. 1-TOUCH SPD DIAL	Registers recipients on one-touch speed dialing keys. Up to 15 recipients can be registered. (See "Storing/Editing One-Touch Speed Dialing Keys/Coded Speed Dialing Codes," on p. 3-7.)
1. NAME	Registers the recipient's name (max. 20 characters, including spaces).
2. TEL NUMBER ENTRY	Registers the recipient's fax/telephone number (max. 50 digits, including spaces).
3. OPTIONAL SETTING	Sets the optional settings for sending faxes.
OFF	The optional setting is not set.
ON	The optional setting is set.
SUBADDRESS	Sets the subaddress (20 digits).
PASSWORD	Sets the password (20 digits).
2. CODED DIAL	Registers recipients for coded speed dialing. Up to 100 recipients can be registered. (See "Storing/Editing One-Touch Speed Dialing Keys/Coded Speed Dialing Codes," on p. 3-7.)
1. NAME	Registers the recipient's name (max. 20 characters, including spaces).
2. TEL NUMBER ENTRY	Registers the recipient's fax/telephone number (max. 50 digits, including spaces).



Back



Previous



Next

- Before Using the Machine 1
- Document and Paper 2
- Sending and Receiving 3
- Copying 4
- Printing (FAX-L160 Only) 5
- System Manager Settings 6
- Maintenance 7
- Troubleshooting 8
- Appendix 9

- Table of Contents
- Index

ADDRESS BOOK SET.

3. OPTIONAL SETTING	Sets the optional settings for sending faxes.
OFF	The optional setting is not set.
ON	The optional setting is set.
SUBADDRESS	Sets the subaddress (20 digits).
PASSWORD	Sets the password (20 digits).
3. GROUP DIAL	Registers destinations in group dialing. Up to 50 destinations can be registered in a group. (See "Storing/Editing One-Touch Speed Dialing Keys/Coded Speed Dialing Codes," on p. 3-7.)
NAME	Registers the group name (max. 20 characters, including spaces).

PRINTER SETTINGS (FAX-L160 Only)

Setting Item	Description
1. ERROR TIME OUT	Sets the length of time before the machine returns an error when no data is received from the computer.
ON	Sets the error time out period. (1SEC-300SEC (15SEC))
OFF	The error time out is off.



Back



Previous



Next

- Before Using the Machine **1**
- Document and Paper **2**
- Sending and Receiving **3**
- Copying **4**
- Printing (FAX-L160 Only) **5**
- System Manager Settings **6**
- Maintenance **7**
- Troubleshooting **8**
- Appendix **9**

TIMER SETTINGS	
Setting Item	Description
1. DATE&TIME SETTING	Sets the current date and time. (See "Set Up the Machine," in the Starter Guide.)
2. DATE TYPE SELECT	Sets the date format. <ul style="list-style-type: none"> - DD/MM YYYY - YYYY MM/DD - MM/DD/YYYY
3. AUTO SLEEP	Sets the auto Sleep mode when the machine remains idle for a certain period of time. (3MIN.–30MIN. (5MIN.)) (See "Setting the Sleep Mode," on p. 1-14.) <ul style="list-style-type: none"> - ON - OFF
4. DAYLIGHT SV.TIME	Sets the daylight saving time mode. (See "Setting Daylight Saving Time," on p. 1-15.)
ON	Activates the daylight saving time mode.
1. BEGIN DATE/TIME	Sets the begin date. <ul style="list-style-type: none"> - 1. MONTH (default: MARCH) - 2. WEEK (default: LAST WEEK) - 3. DAY (default: SUNDAY)
2. END DATE/TIME	Sets the end date. <ul style="list-style-type: none"> - 1. MONTH (default: OCTOBER) - 2. WEEK (default: LAST WEEK) - 3. DAY (default: SUNDAY)
OFF	Deactivates the daylight saving time mode.

- Table of Contents
- Index



Back



Previous



Next

TOP

Before Using the Machine 1

Document and Paper 2

Sending and Receiving 3

Copying 4

Printing (FAX-L160 Only) 5

System Manager Settings 6

Maintenance 7

Troubleshooting 8

Appendix 9

Table of Contents

Index

ADJUST./CLEANING

Setting Item	Description
1. FIX.UNIT CLEANING	Cleans the fuser roller. (See "Fuser Roller," on p. 7-6.)
2. SPECIAL MODE U	Select to improve print quality in high temperature and high humidity conditions or in low temperature and low humidity conditions. - OFF - ON

REPORT SETTINGS

Setting Item	Description
1. SETTINGS	Sets the report functions. (See "Printing Reports Automatically," on p. 9-19.)
1. TX REPORT	Sets whether the transmission report prints out.
PRINT ERROR ONLY	Prints a report only when a transmission error occurs.
OUTPUT NO	No report is printed.
OUTPUT YES	Prints a report every time you send a document.
2. RX REPORT	Sets whether the reception report prints out. - OUTPUT NO - OUTPUT YES - PRINT ERROR ONLY
3. ACTIVITY REPORT	Sets whether an activity report is printed automatically every 60 transactions. - OUTPUT YES - OUTPUT NO



Back



Previous



Next

TOP

Before Using the Machine 1

Document and Paper 2

Sending and Receiving 3

Copying 4

Printing (FAX-L160 Only) 5

System Manager Settings 6

Maintenance 7

Troubleshooting 8

Appendix 9

Table of Contents

Index

REPORT SETTINGS

2. LIST PRINT	Prints reports/lists.
1. TX REPORT	Prints the fax transmission report manually.
2. RX REPORT	Prints the fax reception report manually.
3. ACTIVITY REPORT	Prints the fax transaction report manually.
4. MEMORY DATA LIST	Prints the list of the reserved jobs in memory.
5. MEMORY IMAGE PRNT	Prints the information and image of the first page of the reserved job.
6. 1-TOUCH LIST	Prints the list of fax/telephone numbers and names registered for one-touch speed dialing.
7. CODED DIAL LIST	Prints the list of fax/telephone numbers and names registered for coded speed dialing.
8. GROUP DIAL LIST	Prints the list of groups registered for group dialing.
9. USER DATA LIST	Prints the setting list registered in the menu. (See "Printing USER DATA LIST," on p. 9-3.)



Back



Previous



Next

TOP

Before Using the Machine 1

Document and Paper 2

Sending and Receiving 3

Copying 4

Printing (FAX-L160 Only) 5

System Manager Settings 6

Maintenance 7

Troubleshooting 8

Appendix 9

Table of Contents

Index

SYSTEM SETTINGS	
Setting Item	Description
1. SYS. MANAGER INFO	Sets the system manager information to protect the contents of <SYSTEM SETTINGS>. Once the system password is set, it must be entered every time you access the <SYSTEM SETTINGS> menu.
1. SYSTEM PASSWORD	Sets the system manager password (up to seven digits).
2. COMMUNICATIONS	Sets the fax communication.
1. COUNTRY SELECT	Select the country or area where the machine is used.
2. MEMORY LOCK	Sets whether to receive and store all documents in memory and not to print automatically. (See "Memory Lock Reception," on p. 3-26.)
OFF	Disables memory lock reception.
ON	Enables memory lock reception.
1. PASSWORD	Registers the password that protects the authority for accessing to memory.
2. MEMORY RX TIME	Sets whether to set a period for memory lock reception.
OFF	Disables setting a period of memory lock reception.
ON	Enables setting a period of memory lock reception. <ul style="list-style-type: none"> - 1. MEM. RX START TIME (default: 00:00) - 2. MEM. RX END TIME (default: 00:00)



Back



Previous



Next

TOP

Before Using the Machine 1

Document and Paper 2

Sending and Receiving 3

Copying 4

Printing (FAX-L160 Only) 5

System Manager Settings 6

Maintenance 7

Troubleshooting 8

Appendix 9

Table of Contents

Index

SYSTEM SETTINGS	
3. R-KEY SETTING	Registers the [R] key to access an outside line easily. (See “Dialing Through a Switchboard,” on p. 3-18.) – PSTN – PBX
3. ACCESS TO DEST.	Sets restriction of the access to recipients.
1. RESTRICT REDIAL	Sets whether to disable the redial function of the [Redial/Pause] key. – OFF – ON
2. CONFIRM FAX NO.	Sets whether to confirm the entered fax numbers each time you send a fax. – OFF – ON
4. UPDATE FIRMWARE	This function is used only when the machine firmware needs to be updated.



Back



Previous



Next

TOP

Before Using the Machine 1

Document and Paper 2

Sending and Receiving 3

Copying 4

Printing (FAX-L160 Only) 5

System Manager Settings 6

Maintenance 7

Troubleshooting 8

Appendix 9

Table of Contents

Index

Summary of Reports and Lists

The machine can generate the following reports and lists.

Report/List	Description
TX REPORT	Shows the transmission result. Can be set to print automatically.
RX REPORT	Shows the reception result. Can be set to print automatically.
ACTIVITY REPORT	Shows the last 60 transactions performed by the machine.
MEMORY DATA LIST	Lists reserved jobs stored in memory.
MEMORY IMAGE PRNT	Shows information and the first page of a reserved job.
1-TOUCH LIST	Lists the recipient numbers registered to all the one-touch speed dialing keys.
CODED DIAL LIST	Lists the recipient numbers registered to all the coded speed dialing.
GROUP DIAL LIST	Lists groups registered for group dialing.
USER DATA LIST	Lists all the current settings and registered sender information.
LOST REPORT	Lists received documents that were lost from the memory due to power cut. Cannot be manually printed out.



Back



Previous



Next

TOP

Before Using the Machine 1

Document and Paper 2

Sending and Receiving 3

Copying 4

Printing (FAX-L160 Only) 5

System Manager Settings 6

Maintenance 7

Troubleshooting 8

Appendix 9

Table of Contents

Index

Printing Reports Automatically

TX REPORT, RX REPORT, and ACTIVITY REPORT can be set to print automatically.

■ TX REPORT

The default setting is <PRINT ERROR ONLY>.

1. Press [Menu].
2. Press [◀] or [▶] to select <REPORT SETTINGS>, then press [OK].
3. Press [◀] or [▶] to select <SETTINGS>, then press [OK].
4. Press [◀] or [▶] to select <TX REPORT>, then press [OK].
5. Press [◀] or [▶] to select the setting you want, then press [OK].
 - <PRINT ERROR ONLY>: Prints a report only when a transmission error occurs.
 - <OUTPUT NO>: Does not print a report. Press [Stop/Reset] to return to the standby mode.
 - <OUTPUT YES>: Prints a report every time you send a document.
6. Press [Stop/Reset] to return to the standby mode.



Back



Previous



Next

TOP

Before Using the Machine 1

Document and Paper 2

Sending and Receiving 3

Copying 4

Printing (FAX-L160 Only) 5

System Manager Settings 6

Maintenance 7

Troubleshooting 8

Appendix 9

Table of Contents

Index

Report Items

The following items are displayed in the Transmission Report:

- **JOB NO.:** Job number
- **MODE:** Mode of transaction (G3 or ECM)
- **NO.:** Sequence number
- **DESTINATION TEL/ID:** Name and number of recipient
- **START TIME:** Date and time of transaction
- **PAGE:** Number of pages sent
- **RESULT:** Result of transaction, transaction duration
 - OK: Transmission successful
 - NG: Transmission failed
 - STOP: Transmission manually canceled before completion
 - MEM. FULL: Memory became full during transmission
 - NO ANSWER: Call not answered
 - PAPER JAM: ADF jam occurs during Manual TX
- **Error code:** For descriptions of error codes, See "Error Codes," on p. 8-16.

RX REPORT

The default setting is <OUTPUT NO>.

1. Press [Menu].
2. Press [◀] or [▶] to select <REPORT SETTINGS>, then press [OK].
3. Press [◀] or [▶] to select <SETTINGS>, then press [OK].
4. Press [◀] or [▶] to select <RX REPORT>, then press [OK].
5. Press [◀] or [▶] to select the setting you want, then press [OK].
 - <OUTPUT NO>: Does not print a report.
 - <OUTPUT YES>: Prints a report every time you receive a document.
 - <PRINT ERROR ONLY>: Prints a report only when a reception error occurs.
6. Press [Stop/Reset] to return to the standby mode.



Back



Previous



Next

TOP

Before Using the Machine 1

Document and Paper 2

Sending and Receiving 3

Copying 4

Printing (FAX-L160 Only) 5

System Manager Settings 6

Maintenance 7

Troubleshooting 8

Appendix 9

Table of Contents

Index

Report Items

The following items are displayed in the Reception Report:

- **JOB NO.:** Job number
- **MODE:** Mode of transaction (G3 or ECM)
- **NO.:** Sequence number
- **DESTINATION TEL/ID:** Number of the sending machine (displayed only if registered in their machine)
- **START TIME:** Date and time of transaction
- **PAGE:** Number of pages received
- **RESULT:** Result of transaction, transaction duration
 - OK: Reception successful
 - NG: Reception failed
- **Error code:** For descriptions of error codes, see “Error Codes,” on p. 8-16.

ACTIVITY REPORT

The default setting is <OUTPUT YES>.

1. Press [Menu].
2. Press [◀] or [▶] to select <REPORT SETTINGS>, then press [OK].
3. Press [◀] or [▶] to select <SETTINGS>, then press [OK].
4. Press [◀] or [▶] to select <ACTIVITY REPORT>, then press [OK].
5. Press [◀] or [▶] to select the setting you want, then press [OK].
 - <OUTPUT YES>: Prints a report after every 60 transactions.
 - <OUTPUT NO>: Does not print a report. Press [Stop/Reset] to return to the standby mode.
6. Press [Stop/Reset] to return to the standby mode.



Back



Previous



Next

TOP

Before Using the Machine 1

Document and Paper 2

Sending and Receiving 3

Copying 4

Printing (FAX-L160 Only) 5

System Manager Settings 6

Maintenance 7

Troubleshooting 8

Appendix 9

Table of Contents

Index

Report Items

The following items are displayed in the Activity Report:

- **NO.: Transaction number (01 to 60)**
- **JOB NO.: Job number**
- **START TIME: Date and time of transaction**
- **MODE: Mode of transaction (G3 or ECM)**
- **DESTINATION TEL/ID: Name and number of recipient**
- **PAGE: Number of pages sent or received**
- **RESULT: Result of transaction, transaction duration**
 - OK: Transaction successful
 - NG: Transaction failed



Back



Previous



Next

TOP

Before Using the Machine 1

Document and Paper 2

Sending and Receiving 3

Copying 4

Printing (FAX-L160 Only) 5

System Manager Settings 6

Maintenance 7

Troubleshooting 8

Appendix 9

Table of Contents

Index

Printing Reports and Lists Manually

You can print the following reports and lists manually.

- TX REPORT
- RX REPORT
- ACTIVITY REPORT
- MEMORY DATA LIST
- MEMORY IMAGE PRNT
- 1-TOUCH LIST
- CODED DIAL LIST
- GROUP DIAL LIST
- USER DATA LIST

If no relevant data is stored in memory, <NO DATA> is displayed.



NOTE
For information on each report or list, see "Summary of Reports and Lists," on p. 9-18.

1. Press [Menu].
2. Press [◀-] or [+▶] to select <REPORT SETTINGS>, then press [OK].
3. Press [◀-] or [+▶] to select <LIST PRINT>, then press [OK].
4. Press [◀-] or [+▶] to select a desired report or list, then press [OK].

Printing starts, and the screen automatically returns to the standby mode.



Back



Previous



Next

TOP

Before Using the Machine 1

Document and Paper 2

Sending and Receiving 3

Copying 4

Printing (FAX-L160 Only) 5

System Manager Settings 6

Maintenance 7

Troubleshooting 8

Appendix 9

Table of Contents

Index

Checking Remaining Memory

You can check the amount of available memory by pressing the System Monitor key.

1. Press [System Monitor].
2. Press [◀] or [▶] to select <AVAILABLE MEMORY>, then press [OK] to confirm the remaining memory.

Ex.

A V A I L A B L E M E M O R Y
7 5 %

3. Press [Stop/Reset] to return to the standby mode.



Back



Previous



Next

TOP

Before Using the Machine 1

Document and Paper 2

Sending and Receiving 3

Copying 4

Printing (FAX-L160 Only) 5

System Manager Settings 6

Maintenance 7

Troubleshooting 8

Appendix 9

Table of Contents

Index

Checking Print and Scan Counts

System monitor allows you to check print and scan counts.

1. Press [System Monitor].
2. Press [◀] or [▶] to select <VIEW PAGE TOTALS>, then press [OK].
3. Press [◀] or [▶] to view the print or scan counts.
4. Press [Stop/Reset] to return to the standby mode.



Back



Previous



Next

TOP

Before Using the Machine 1

Document and Paper 2

Sending and Receiving 3

Copying 4

Printing (FAX-L160 Only) 5

System Manager Settings 6

Maintenance 7

Troubleshooting 8

Appendix 9

Table of Contents

Index

Glossary

A

Activity Report

A journal of the machine's transactions, both sent and received.

Address Book

The Address Book is a feature used for storing fax recipients. The Address Book is divided into one-touch speed dialing keys and coded speed dialing codes. You can register multiple recipients in a group, and assign a one-touch speed dialing key to this group. Registering a destination in the Address Book saves you the effort of entering that fax number each time you send a fax.

Automatic Document Feeder (ADF)

The device included in the machine that feeds the document being sent or copied, or scanned into the machine.

Automatic redialing

When the recipient's machine is busy or does not answer, or when an error occurs while sending, the machine waits a specified time and then automatically redials the number. If the receiving fax is still busy or does not answer, the machine waits the specified time and dials again.

B

bps

Bits per second. Refers to the speed with which a fax machine sends and receives data.

Broadcasting

Transmitting documents to more than one location (through the machine's memory).

Buffer size

The size of a data area, or buffer, shared by devices or programs working at different speeds or with different priorities. The buffer is designed to prevent one device or process from being held up by another. For this to be possible, the buffer must be set up correctly.

C

CNG

Calling Tone. This is a signal sent by fax machines to identify the call as an incoming document. When the receiving fax detects this signal, it automatically starts to receive the fax transmission. The majority of fax machines in use today can send and detect CNG signals.



Back



Previous



Next

TOP

Before Using the Machine 1

Document and Paper 2

Sending and Receiving 3

Copying 4

Printing (FAX-L160 Only) 5

System Manager Settings 6

Maintenance 7

Troubleshooting 8

Appendix 9

Table of Contents

Index

Coded Speed Dialing Codes

A method to specify a recipient registered in Address Book. Press [Coded Dial] and a two-digit code using the numeric keys.

Cookie

A file left on a user's computer when the user visits a web site. A cookie allows the web site to recognize the user on subsequent visits. Cookies are generally used to enable a user to automatically sign on to certain web sites and to customize the features offered by such sites.

Cursor

The underline symbol you see on the LCD when you register numbers and names in the machine.

D

Document

The sheet of paper containing the data that you send to, or receive from a machine.

dpi

Dots per inch. A machine of measurement for indicating a machine's resolution.

E

ECM

Error Correction Mode. The ability of your machine to reduce system and line errors when sending or receiving from another fax with ECM capability. ECM is most effective in areas where the telephone lines are in poor condition or there is frequent interference on the line.

Extension

A telephone connected to the machine that is used in place of the handset. You can use the extension telephone to activate incoming reception of documents manually.

F

FAX/TEL switching

This option allows you to set the machine to automatically detect whether a call is from a fax or telephone. If the call is from another fax, the transmission is automatically received. If the call is from a telephone, the machine rings to let you know, so you can pick up the handset. With this feature, one telephone line can be shared by both the telephone and the fax.

FINE

The resolution setting for documents with very small characters and lines.



Back



Previous



Next

TOP

Before Using the Machine 1

Document and Paper 2

Sending and Receiving 3

Copying 4

Printing (FAX-L160 Only) 5

System Manager Settings 6

Maintenance 7

Troubleshooting 8

Appendix 9

Table of Contents

Index

G

G3, Group 3 fax machine

Defined by CCITT/ITU-T. Uses encoding schemes to transmit image data while reducing the amount of data that needs to be transmitted, thus reducing transmission time. G3 fax machines can transmit one page in less than one minute. Encoding schemes for G3 fax machines are Modified Huffman (MH), Modified READ (MR), Modified Modified READ (MMR), and Joint Bi-level Image expert Group (JBIG).

Group Dialing

A method of specifying recipients that enables you to specify multiple recipients registered in Address Book as a group. This means that you can press just a single one-touch speed dialing key to specify recipients when sending the same document to many recipients.

H

HP-GL/2

A graphics language that allows computer applications to draw graphic images using printers. Images in HP-GL/2 are represented as vector graphics. Vector objects describe an image in terms of geometric shapes, such as lines and polygons, and fills. HP-GL/2 is supported by your Canon machine.

I

Interface

The connection between two devices that makes it possible for them to communicate with each other. The machine features a USB interface, which makes it compatible with IBM and similar personal computers.

Interface cable

The cable used to create the interface between a printer and a computer.

Interface port

The machine comes with one USB port, located on the back of the machine. You attach the cable that connects your computer and machine to this port.

ITU-T

A committee created to set international standards for telecommunications.

L

Log in

Entering a password as a means of user authentication to start a computer session or access to a service.

LPD

Line Printer Daemon. A daemon is a program that runs, without human intervention, to accomplish a given task. The Line Printer Daemon controls the flow of print jobs to a printer.



Back



Previous



Next

- Before Using the Machine 1
- Document and Paper 2
- Sending and Receiving 3
- Copying 4
- Printing (FAX-L160 Only) 5
- System Manager Settings 6
- Maintenance 7
- Troubleshooting 8
- Appendix 9

- Table of Contents
- Index

M

Manual receiving

A method of receiving faxes in which you answer all incoming calls using the optional handset or the external telephone. If you hear a slow beep it indicates an incoming fax transmission from another machine. Just press [Start] to receive the incoming fax.

N

Numeric keys

The round, numbered keys on the operation panel marked the same as a standard telephone keypad. Press them to perform regular dialing. You also use the numeric keys to enter characters and numbers during registration, and for entering coded speed dialing codes.

O

One-Touch Speed Dialing keys

The numbered keys on the operation panel that may be registered as single or a group of recipients. Once a number or group is registered, you press one key to dial the entire number or group.

P

Paper feed

Refers to guiding a sheet of paper into the machine's paper path.

Paper feeder

The device in the machine that feeds recording media into the machine for printing copied or sent documents.

Pause

A timing entry required for registering certain long distance numbers and for dialing out through some telephone systems or switchboards. Pressing [Redial/Pause] enters a pause between digits of a telephone number.

PDF

Portable Document Format. The page description language used in Adobe Systems' Acrobat document exchange system, which is restricted neither by device nor resolution. PDF displays documents in a way that is independent of the original application software, hardware, and operating system used to create those documents. A PDF document can contain any combination of text, graphics, and images.

PHOTO

The document setting you use for sending or copying documents with intermediate tones, such as photographs.

Polling

One fax machine requesting another to send a document. The receiving party calls the fax machine holding the document to be sent, and requests that it be sent.

Pulse

See Rotary pulse.



Back



Previous



Next

- Before Using the Machine 1
- Document and Paper 2
- Sending and Receiving 3
- Copying 4
- Printing (FAX-L160 Only) 5
- System Manager Settings 6
- Maintenance 7
- Troubleshooting 8
- Appendix 9

R

Raster

Raster graphics describes an image as a pattern of dots, compared to vector graphics which represents an image as a geometrical formula. Each row of color dots in the mosaic of color dots constitutes one raster graphic. In a printer, a raster graphic is used as the master image from which a page is printed, because the image can be transferred to paper by printing one raster at a time.

Receiving

Receiving transmission is also defined as RX or Reception. The machine can be customized to receive fax documents in several ways.

Reception

See Receiving.

Redialing-automatic

See Automatic redialing.

Registering

A process by which you place recipient's information (such as the name, fax number) in the machine's memory, so that you save time specifying recipients you send documents frequently.

Regular dialing

Pressing the individual numeric keys to dial a fax or telephone number.

Remote reception ID

The two-digit code that enables you to manually activate fax reception using an external telephone.

Remote reception

Activating fax reception by answering an external telephone that is not located near the machine. You need to dial a remote receiving ID number to start remote reception.

Report

A document printed by the machine and containing information about the documents it has sent or received.

Resolution

The density of dots for any given output device. Expressed in terms of dots per inch (dpi). Low resolution causes font characters and graphics to have a jagged appearance. Higher resolution means smoother curves and angles as well as a better match to traditional typeface designs. Resolution values are represented by horizontal data and vertical data, for example, 600 x 600 dpi.

RIP (Raster Image Processor)

The hardware and/or software functions of a printer that convert vector graphic descriptions from a computer into raster graphic images that can be printed.

Rotary pulse

A telephone dialing system where a dial is rotated to send pulses to the telephone switching system. In pulse dialing, you hear clicks. In touch-tone dialing, the most common dialing system, you hear tones. Rotary pulse dialing requires certain setting adjustments.

RX

See Receiving.



Back



Previous



Next

TOP

Before Using the Machine 1

Document and Paper 2

Sending and Receiving 3

Copying 4

Printing (FAX-L160 Only) 5

System Manager Settings 6

Maintenance 7

Troubleshooting 8

Appendix 9

Table of Contents

Index

S

Sending

Sending documents is also defined as TX or Transmit. The machine can scan and send documents via fax.

Sending speed

The rate at which faxes are transmitted through the phone line. See also bps (bits per seconds).

Standby

The mode in which the machine is on and ready to use.

Subaddress

Subaddress is the global telecommunications standard specified by the ITU-T. When the remote party's machine supports the same standard, confidential or relayed communications are possible by attaching a subaddress and a password in advance.

T

Tone

A key that allows you to temporarily switch to touch-tone from pulse dialing. In some countries, on-line data services may require that you use tone dialing.

Tone/pulse setting

The ability to set the machine to match the telephone dialing system your telephone line uses: touch-tone or rotary pulse.

Toner

A black, resin coated powder contained in the toner cartridge. The machine applies the toner to the surface of the photosensitive drum inside the machine via an electrophotographic mechanism.

Toner saver

The feature that extends cartridge life by reducing toner consumption rate at a slight decrease in print quality.

Transmit

See Sending.

TX

See Sending.

V

Vector Graphics

See Raster.



Back



Previous



Next

TOP

Before Using the Machine 1

Document and Paper 2

Sending and Receiving 3

Copying 4

Printing (FAX-L160 Only) 5

System Manager Settings 6

Maintenance 7

Troubleshooting 8

Appendix 9

Table of Contents

Index

Index

A

- Accessing the setting menu 9-3
- ACTIVITY REPORT
 - Printing automatically 9-21
- Add. Mode key 1-7
- Address Book
 - Fax numbers 3-7
 - Storing/Editing 3-7
- Address Book key 1-8
- ADDRESS BOOK SET. 9-3, 9-11
- ADF 1-4
- ADJUST./CLEANING 9-3, 9-14
- Advanced features 3-30
- Advanced printing features 5-3

B

- Basic receiving method 3-23
- Basic sending method 3-5
- Before using the machine 1-1
- Broadcasting 3-30

C

- Canceling
 - Copy job 4-5
 - TX/RX job 3-34
- CHECK DOCUMENT message 8-3

Checking

- Documents stored in memory 3-35
- Print job 5-4
- Reception results 3-35
- Transmission result 3-35

Checking dialing line 3-21

Cleaning machine

- Exterior 7-2
- Interior 7-2
- Scanning area 7-6

Clearing jams 8-3

- Document jams 8-3
- Paper jams 8-5

Clear key 1-7

Coded Dial key 1-8, 3-14

Coded speed dialing codes

- Deleting 3-10
- Editing 3-9
- Registering 3-7
- Storing/Editing 3-7
- Using 3-14

Collate Printing 5-3

COMMON SETTINGS 9-3, 9-6

Components 1-3

Copying 4-1

Copy job

- Canceling 4-5

Copy key 1-7

Copy mode 1-9

COPY SETTINGS 9-3, 9-6

D

Daylight saving time 1-15

Deleting

- Documents stored in memory 3-35
- Print job 5-4

Density

- Copying 4-3
- Sending 3-6

Density key 1-7

Document

- Copying 4-2
- Jams 8-3
- Loading 2-4
- Printing 5-2
- Receiving 3-1
- Requirements 2-2
- Scanning area 2-3
- Sending 3-1

Document and paper 2-1

Document delivery tray 1-4

Document feeder tray 1-3

Document feeder tray extension 1-3

Document guides 1-4

Document release lever 1-4

Document requirements 2-2

Documents stored in memory

- Checking 3-35
- Deleting 3-35



Back



Previous



Next

Before Using the Machine 1

Document and Paper 2

Sending and Receiving 3

Copying 4

Printing (FAX-L160 Only) 5

System Manager Settings 6

Maintenance 7

Troubleshooting 8

Appendix 9

Table of Contents

Index

E

- Error codes 8-16
- Energy Saver key 1-6
- External device jack 1-5

F

- FAX/TEL 3-24
- Fax dialing features 3-18
- Fax mode 1-9
- Fax numbers
 - Registering in Address Book 3-7
- FAX SETTINGS 9-3, 9-7
- Fuser Roller 7-6

G

- Glossary 9-26
- Group dialing
 - Adding recipients 3-11
 - Changing name 3-12
 - Deleting group 3-13
 - Deleting recipients 3-12
 - Registering group 3-10
 - Using 3-15

H

- Handset cable retainer 1-5
- Handset jack 1-5
- Hook key 1-8, 3-17

I

- If a power failure occurs 8-36
- If you cannot solve a problem 8-37

- Image quality
 - Copying 4-3
 - Faxes 3-6
- Image Quality key 1-8

J

- Jams
 - Document 8-3
 - Paper 8-5

L

- LCD
 - Messages 8-10
 - Standby mode 1-9
- LCD display 1-6
- Line jack 1-5
- Loading
 - Document 2-4
 - Paper 2-8
- Loading Envelopes 2-8

M

- Machine components 1-3
- Machine settings 9-3
- Maintaining the toner cartridge 1-12
- Maintenance 7-1
- Manual reception 3-25
- Manual sending 3-17
- Memory lock reception 3-26
- Memory reception 3-25
- Menu
 - Accessing 9-3
 - Setting 9-5

Menu key 1-7

N

- Notch 1-3
- Numeric keys 1-8

O

- OK key 1-6
- One-touch speed dialing keys 1-6
 - Deleting 3-10
 - Editing 3-9
 - Registering 3-7
 - Storing/Editing 3-7
 - Using 3-14
- Operation panel 1-3, 1-6
- Overseas number 3-21

P

- Paper
 - Jams 8-5
 - Loading 2-8
 - Printable area 2-7
 - Requirements 2-5
 - Size and type 2-11
- Paper delivery tray 1-3
- Paper delivery tray extension 1-3
- PAPER JAM message 8-5
- Paper requirements 2-5
- PAPER SETTINGS 9-3, 9-5
- Paper stack cover 1-4
- Power failure 8-36
- Power socket 1-5
- Printable area 2-7



Back



Previous



Next

- Before Using the Machine **1**
- Document and Paper **2**
- Sending and Receiving **3**
- Copying **4**
- Printing (FAX-L160 Only) **5**
- System Manager Settings **6**
- Maintenance **7**
- Troubleshooting **8**
- Appendix **9**

- Table of Contents
- Index

PRINTER SETTINGS 9-3, 9-12

Printing 5-1

 USER DATA LIST 9-3

Printing reports

 ACTIVITY REPORT 9-21

 RX REPORT 9-20

 TX REPORT 9-19

Print job

 Checking 5-4

 Deleting 5-4

Processing/Data indicator 1-7

Pulse dialing 3-19

R

Received image reduction 3-29

Receive mode

 AnsMode 3-23

 FAX/TEL 3-24

 FaxOnly 3-23

 Manual 3-25

Receiving documents

 Basic receiving method 3-23

 Receiving features 3-24

Receiving features 3-24

Redial/Pause key 1-8

Redistributing toner 7-8

Remote reception 3-27

Remote reception ID 3-27

Replacing the toner cartridge 7-8

Reports and lists 9-18

REPORT SETTINGS 9-3, 9-14

Restricting access to destinations

 Confirm entered fax numbers 6-3

R key 1-8

RX REPORT

 Printing automatically 9-20

S

Scanning area 2-3

Scan settings

 Copying 4-3

 Sending 3-6

Sending and receiving 3-1

Sending documents

 Address Book 3-7

 Advanced features 3-30

 Basic sending method 3-5

 Fax dialing features 3-18

 Manual sending 3-17

 Scan settings 3-6

 Specifying recipients 3-14

Setting menu

 ADDRESS BOOK SET. 9-11

 COMMON SETTINGS 9-6

 COPY SETTINGS 9-6

 FAX SETTINGS 9-7

 PAPER SETTINGS 9-5

 PRINTER SETTINGS 9-12

 REPORT SETTINGS 9-14

 SYSTEM SETTINGS 9-16

 TIMER SETTINGS 9-13

 VOLUME CONTROL 9-5

Setting paper size and type 2-11

Sleep Mode 1-14

Specifying recipients 3-14

Standby mode

 Copy 1-9

 Fax 1-9

Start key 1-7

Stop/Reset key 1-7

Storing/Editing

 Address Book 3-7

 Coded speed dialing 3-7

 Group dialing 3-10

 One-touch speed dialing codes keys 3-7

System Manager settings 6-1

System monitor 3-35, 5-4

System Monitor key 1-8

SYSTEM SETTINGS 9-3, 9-16

T

TIMER SETTINGS 9-3, 9-13

Timer settings 1-14

Tone dialing 3-19

Tone key 1-7, 3-19

Toner cartridge 1-11

 Maintaining 1-12

 Redistributing 7-8

 Replacing 7-12

Toner cover 1-3

Transporting the machine 7-17

Troubleshooting

 Clearing jams 8-3

 Copying 8-30

 Error codes 8-16

 General 8-19

 If a power failure occurs 8-36

 If you cannot solve a problem 8-37

 LCD messages 8-10

 Paper feeding 8-20

 Printing 8-32

 Sending/Receiving 8-21

 Telephone 8-35



Back



Previous



Next

TOP

Before Using the Machine 1

Document and Paper 2

Sending and Receiving 3

Copying 4

Printing (FAX-L160 Only) 5

System Manager Settings 6

Maintenance 7

Troubleshooting 8

Appendix 9

TX REPORT

Printing automatically 9-19

U

USB port 1-5

USER DATA LIST 9-3

Using

Address Book key 3-15

Coded speed dialing 3-14

Group dialing 3-15

One-touch speed dialing keys 3-14

V

VOLUME CONTROL 9-3, 9-5

Table of Contents

Index



Back



Previous



Next

TOP

Before Using the Machine 1

Document and Paper 2

Sending and Receiving 3

Copying 4

Printing (FAX-L160 Only) 5

System Manager Settings 6

Maintenance 7

Troubleshooting 8

Appendix 9

Canon

CANON INC.

30-2, Shimomaruko 3-chome, Ohta-ku, Tokyo 146-8501, Japan

CANON U.S.A., INC.

One Canon Plaza, Lake Success, NY 11042, U.S.A.

CANON CANADA INC.

6390 Dixie Road Mississauga, Ontario L5T 1P7, Canada

CANON EUROPA N.V.

Bovenkerkerweg 59-61 1185 XB Amstelveen, The Netherlands

CANON FRANCE S.A.S.

17, quai du Président Paul Doumer 92414 Courbevoie Cedex, France

CANON COMMUNICATION & IMAGE FRANCE S.A.S.

12, rue de l'Industrie 92414 Courbevoie Cedex, France

CANON (U.K.) LTD.

Woodhatch, Reigate, Surrey, RH2 8BF, United Kingdom

CANON DEUTSCHLAND GmbH

Europark Fichtenhain A10, 47807 Krefeld, Germany

CANON ITALIA S.p.A.

Via Milano, 8 20097 San Donato Milanese (MI) Italy

CANON ESPAÑA, S.A.

c/ Joaquín Costa 41, 28002 Madrid, Spain

CANON LATIN AMERICA, INC.

703 Waterford Way Suite 400, Miami, Florida 33126 U.S.A.

CANON AUSTRALIA PTY. LTD.

1 Thomas Holt Drive, North Ryde, Sydney, N.S.W. 2113, Australia

CANON CHINA CO., LTD.

15F Jinbao Building No.89 Jinbao Street, Dongcheng District, Beijing 100005, China

CANON SINGAPORE PTE. LTD.

1 HarbourFront Avenue #04-01 Keppel Bay Tower, Singapore 098632

CANON HONGKONG CO., LTD.

19/F., The Metropolis Tower, 10 Metropolis Drive, Hungghom, Kowloon, Hong Kong

Table of Contents

Index